



Woven, Tartan Ceiling Frames

WoodGrain Collection

Woven's Tartan design features a symmetrical arrangement of vertical and horizontal stripes, forming a striking grid of overlapping squares. This carefully crafted pattern achieves a dynamic balance of openness and acoustic performance, improving the experience of any space. It easily integrates with ceiling elements such as sprinklers, speakers, and lighting, while enhancing both aesthetics and functionality.

Specifications

Surface	Ceiling	
Material	FilaSorb™ polyester felt	
Thickness	1/2", 12mm (±10%)	
Weight	0.49 lb./ft ² (±10%)	
Standard Sizes	4" H x 24" W x 24" L 6" H x 24" W x 24" L	
Compatible T-grid	Type	Layout
	15/16" Flat	Standard 24" x 24"
	9/16" Flat	Standard 24" x 24"



Woven, Tartan Ceiling Frames in Boardwalk

Technical

NRC Rating	Pending product testing
Fire Test	ASTM E84, Class A Flame spread index: 15 Smoke developed index: 200
Water Sorption	ASTM C1104-2019 (A Modified) Water sorbed by weight: 0.20% (based on a 12mm thick panel)
Colorfastness	ISO 105-B02, 6-7

Details

Lead Time	3 – 6 weeks
Origin	Manufactured and assembled in the US
Warranty	Product: 20 years* Colorfastness: 20 years*

* Conditions apply

Environmental

Recycled Content	Minimum 60%
Energy	Generated using 40% solar energy
Indoor Air Quality	VOC less than/equal to 0.5mg/m ³
Recyclable	100%*
Certifications	Declare Certification - LBC Red List Free (third-party verified) SCS Global Indoor Advantage Gold

* PET is recyclable through participating partners.



Call **800.966.8557** with questions or visit **acoufelt.com** for more product information, downloads, and colorways.

Colorways

WOODGRAIN



Boat Shed
WQ02



Picket Fence
WQ01



Loft
WQ06



Nordic Plank
WQ15



White Oak
WQ13



Baltic Birch
WQ12



White Elm
WQ07



Lyed Larch
WQ30



Woodland Fog
WQ22



Weathered Slate
WQ14



French Bobbin
WQ08



Boardwalk
WQ10



Mountain Lodge
WQ24



Wine Barrel
WQ03



Natural Oak
WQ16



Knotty Spruce
WQ29

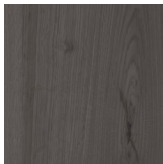

Shadow Oak
WQ28



Driftwood
WQ21



Mocha Legno
WQ25



Teak
WQ18



Fumed Oak
WQ19

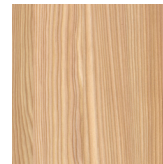

European Larch
WQ17



Petrified Ash
WQ23

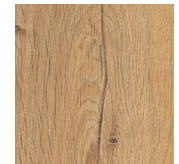

Log Cabin
WQ04



Charred Larch
WQ09

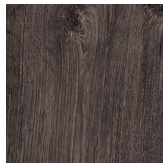

Barn Door
WQ05

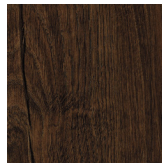

Antique Chest
WQ11

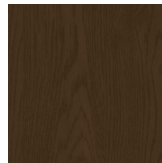

Scorched Timber
WQ26

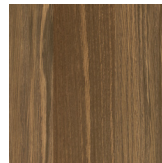

Espresso Oak
WQ27

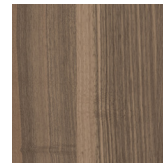

Black Walnut
WQ20

Order samples at acoufelt.com/colorways

How to Specify

1. Choose Slat Height

2. Choose Colorways

Slats are available in two heights:

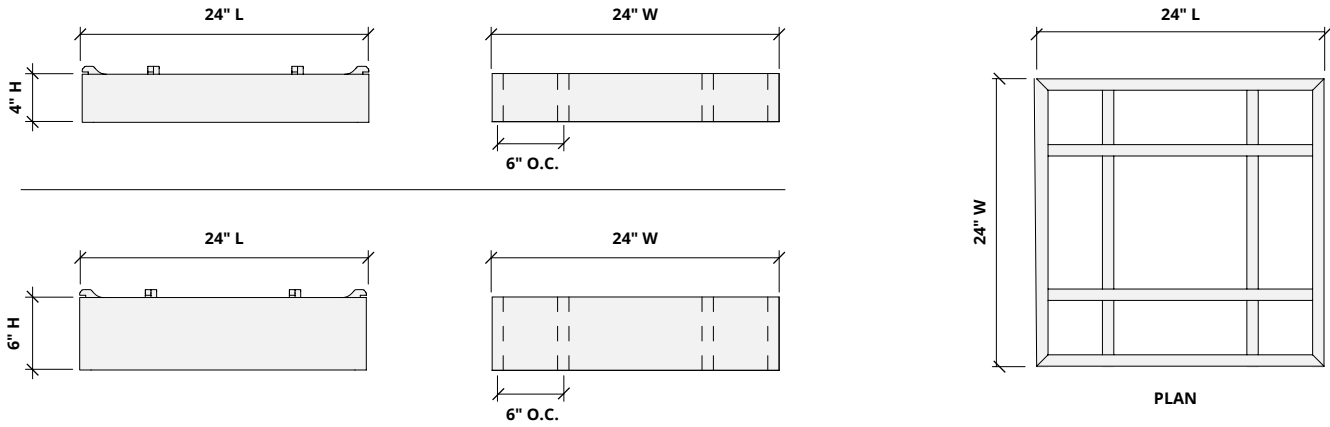

1. Choose Slat Height

2. Choose Colorways

See colorway choices on page 3.

