



Vista, Desert Ceiling Frames

WoodGrain Collection

Evenly arranged cubes of the Vista Desert design mimic a calming, open expanse of land while ensuring superior sound management. Choose a single Premier color or WoodGrain option or select two complementary finishes for the cubes and the backing. Modern, modular, and easy to install, Vista can change your outlook about working or meeting in a crowded space.

Specifications

Surface	Ceiling	
Material	FilaSorb™ polyester felt	
Thickness	1/2", 12mm (±10%)	
Weight	0.49 lb./ft ² (±10%)	
Standard Sizes	Height	Backer Panels
	3, 6" H	24" W x 24" L
Compatible T-grid	Type	Layout
	15/16" Flat	Standard 24" x 24"
	9/16" Flat	Standard 24" x 24"

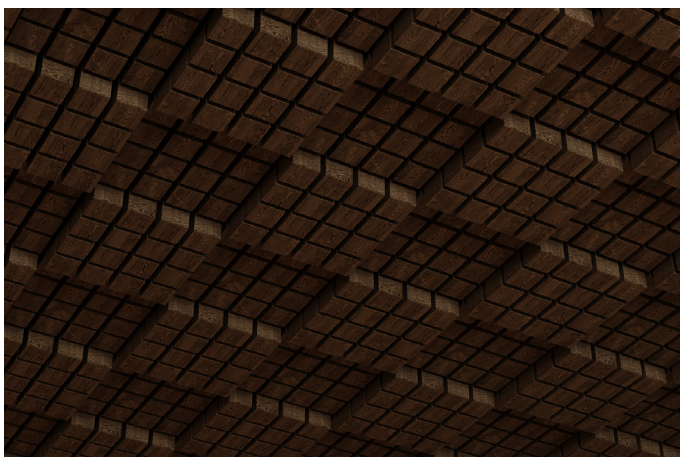

Vista, Desert Ceiling Frames in Scorched Timber

Technical

NRC Rating	Pending product testing
Fire Test	ASTM E84, Class A
	Flame spread index: 15
	Smoke developed index: 200
Water Sorption	ASTM C1104-2019 (A Modified)
	Water sorbed by weight: 0.20% (based on a 12mm thick panel)
Colorfastness	ISO 105-B02, 6-7

Details

Lead Time	3 – 6 weeks
Origin	Manufactured and assembled in the US
Warranty	Product: 20 years*
	Colorfastness: 20 years*

* Conditions apply

Environmental

Recycled Content	Minimum 60%
Energy	Generated using 40% solar energy
Indoor Air Quality	VOC less than/equal to 0.5mg/m ³
Recyclable	100%*
Certifications	Declare Certification - LBC Red List Free (third-party verified)
	SCS Global Indoor Advantage Gold

* PET is recyclable through participating partners.



Colorways

WOODGRAIN



Boat Shed
WQ02



Picket Fence
WQ01



Loft
WQ06



Nordic Plank
WQ15



White Oak
WQ13



Baltic Birch
WQ12



White Elm
WQ07



Lyed Larch
WQ30



Woodland Fog
WQ22



Weathered Slate
WQ14



French Bobbin
WQ08



Boardwalk
WQ10



Mountain Lodge
WQ24



Wine Barrel
WQ03



Natural Oak
WQ16



Knotty Spruce
WQ29



Shadow Oak
WQ28



Driftwood
WQ21



Mocha Legno
WQ25



Teak
WQ18



Fumed Oak
WQ19

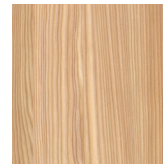

European Larch
WQ17



Petrified Ash
WQ23

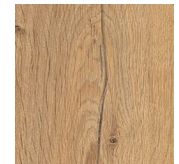

Log Cabin
WQ04



Charred Larch
WQ09

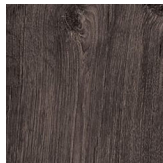

Barn Door
WQ05

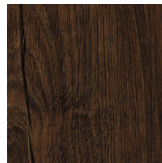

Antique Chest
WQ11

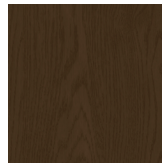

Scorched Timber
WQ26

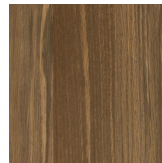

Espresso Oak
WQ27

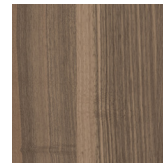

Black Walnut
WQ20

Order samples at acoufelt.com/colorways

Colorways

PREMIER



White
WH12



Almond
AL55



Celery
CE65



Sencha
SE58

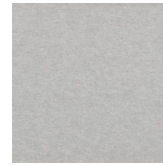

Metal
ME03



Flamingo
FL61



Quartz
QU67



Turmeric
TU60



Platinum
PL04



Pearl
PE21



Pistachio
PI25



Thistle
TH28



Stonewash
ST72



Amethyst
AM69



Valentine
VA70



Wheat
WH68



Grey
GR02



Ivory
IV11



Eucalyptus
EU71



Peacock
PE20



Periwinkle
PE23

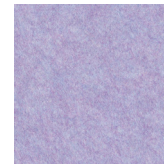

Lilac
LI13



Peach
PE19



Popcorn
PO26

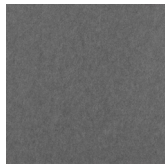

Slate
SL27



Milkyway
MI74



Wasabi
WA29



Sea Salt
SE57



Marine
MA15



Berry
BE06



Peppercorn
PE22

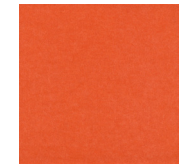

Carrot
CA08



Charcoal
CH01



Umber
UM54



Oregano
OR18



Azure
AZ05



Granite
GR62



Iris
IR10

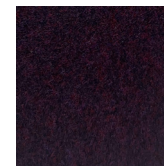

Shiraz
SH63



Currant
CU59

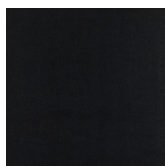

Piano Black
PI24



Walnut
WA56

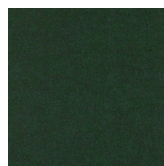

Kale
KA12

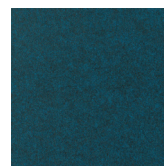

Denim
DE09

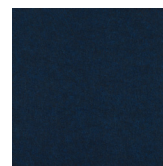

Midnight
MI16

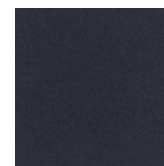

Flint
FL64

Order samples at acoufelt.com/colorways



Call 800.966.8557 with questions or visit acoufelt.com for more product information, downloads, and colorways.

Sizes

Standard Heights	3, 6" H
Standard Widths	24" W
Thickness	1/2", 12mm (±10%)

Standard Length 24" L

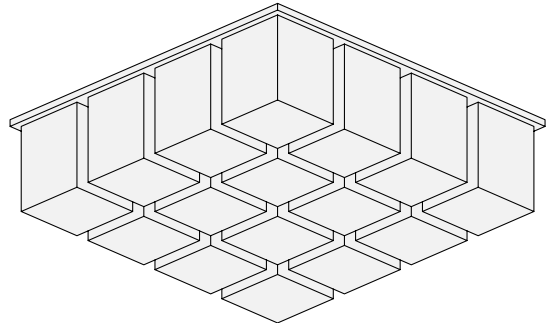
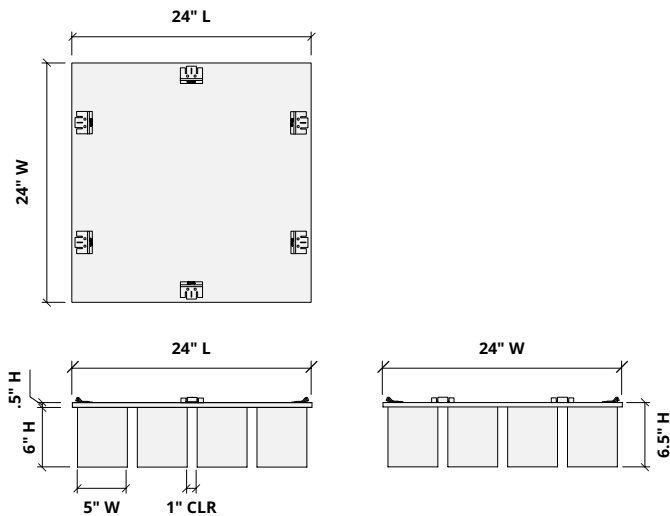
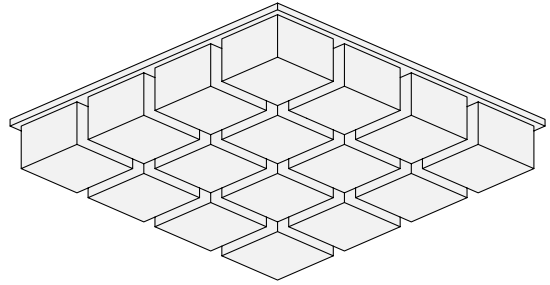
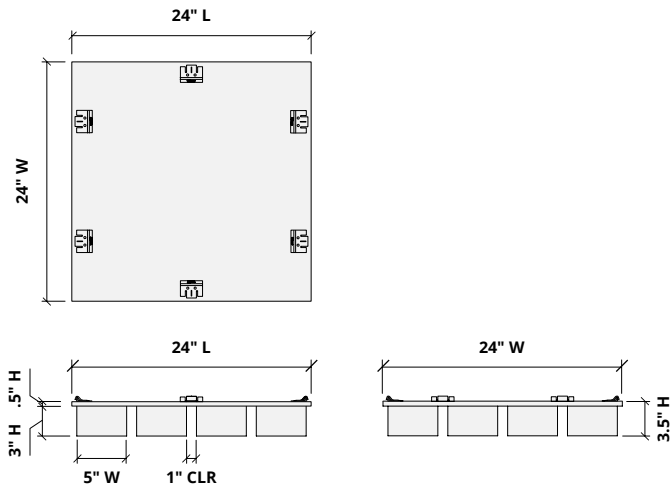

Choose Colorways

Select one colorway for your cubes and one colorway for your backer panel; or one colorway for both. See colorway choices on pages 3 and 4.

If you're specifying dark colored backer panels, we recommend dark drop ceiling grids (not provided).

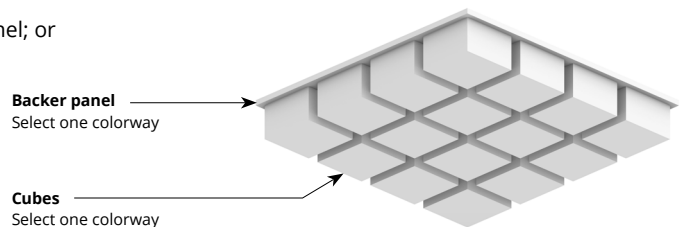

Lighting Coordination

24" x 24", 24" x 48" Grid light

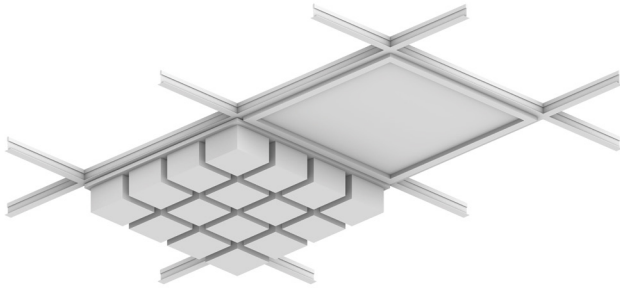

Drop pendant light

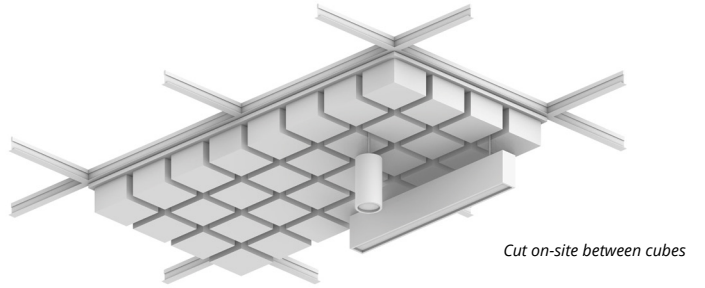

Recessed light

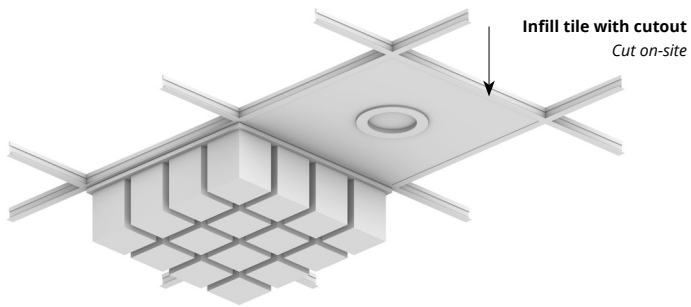

Grid mounted light (track, pendant)

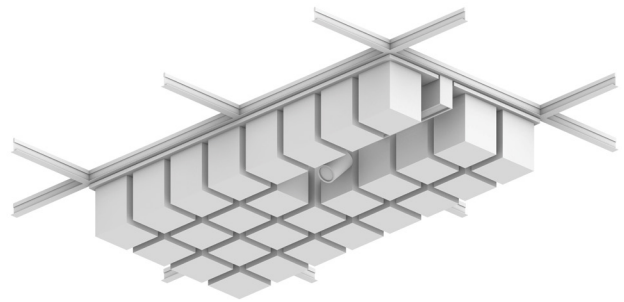

Recommended Layout

