



# QuietForm Wall Panels

Premier Collection

The QuietForm™ panel is a thermal-molded acoustic solution that combines striking three-dimensional wall designs with transformative soundscaping functionality. Available in a wide spectrum of Premier color options, QuietForm panels can be effortlessly installed over any existing wall surface. With a variety of designs to choose from and the flexibility to rotate panels for unique patterns, QuietForm empowers creativity while enhancing both aesthetics and acoustic performance.

## Specifications

<b>Surface</b>	Wall
<b>Material</b>	FilaSorb™ polyester felt
<b>Thickness</b>	1/2", 8mm (±10%) range to 1", 24mm (±10%)
<b>Weight</b>	0.49 lb./ft <sup>2</sup> (±10%) 0.98 lb./ft <sup>2</sup> (±10%)
<b>Standard Sizes</b>	48" W x 110" H Geometry pattern, 108" H



QuietForm Wall Panel with Celestial A Pattern in Eucalyptus

## Technical

<b>NRC Rating</b>	<b>12mm</b> 0.45, no air gap 0.60, 20mm air gap 0.75, 50mm air gap <b>24mm</b> 0.60, no air gap
<b>Fire Test</b>	ASTM E84, Class A Flame spread index: 15 Smoke developed index: 200
<b>Water Sorption</b>	ASTM C1104-2019 (A Modified) Water sorbed by weight: 0.20% (based on a 12mm thick panel)
<b>Colorfastness</b>	ISO 105-B02, 6-7

## Details

<b>Lead Time</b>	3 – 6 weeks
<b>Origin</b>	Manufactured and assembled in the US
<b>Warranty</b>	Product: 20 years* Colorfastness: 20 years*

\* Conditions apply

## Environmental

<b>Recycled Content</b>	Minimum 60%
<b>Energy</b>	Generated using 40% solar energy
<b>Indoor Air Quality</b>	VOC less than/equal to 0.5mg/m3
<b>Recyclable</b>	100%*
<b>Certifications</b>	Health Product Declaration (HPD)** Declare Certification - LBC Red List Free (third-party verified) SCS Global Indoor Advantage Gold

\* PET is recyclable through participating partners.

\*\* HPD only applies to 12mm thickness.



© The Health Product Declaration® logo is a registered trademark of HPD Collaborative.



Call **800.966.8557** with questions or visit **acoufelt.com** for more product information, downloads, and colorways.

# Colorways

## PREMIER



White  
WH12



Almond  
AL55



Celery  
CE65



Sencha  
SE58



Metal  
ME03



Flamingo  
FL61



Quartz  
QU67



Turmeric  
TU60

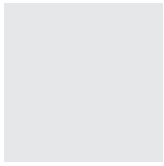

Platinum  
PL04



Pearl  
PE21



Pistachio  
PI25



Thistle  
TH28



Stonewash  
ST72



Amethyst  
AM69



Valentine  
VA70



Wheat  
WH68



Grey  
GR02



Ivory  
IV11



Eucalyptus  
EU71



Peacock  
PE20



Periwinkle  
PE23

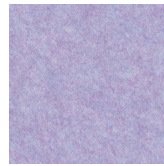

Lilac  
LI13



Peach  
PE19

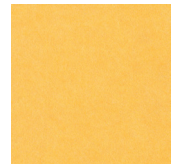

Popcorn  
PO26

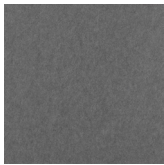

Slate  
SL27



Umber  
UM54



Wasabi  
WA29



Sea Salt  
SE57



Marine  
MA15



Berry  
BE06



Peppercorn  
PE22



Carrot  
CA08



Charcoal  
CH01



Walnut  
WA56



Oregano  
OR18



Azure  
AZ05



Iris  
IR10

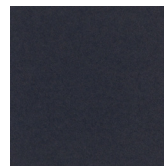

Flint  
FL64

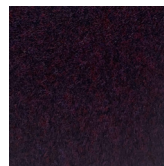

Shiraz  
SH63

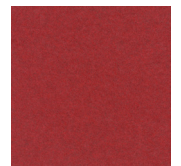

Currant  
CU59



Piano Black  
PI24

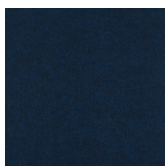

Midnight  
MI16

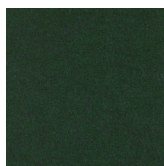

Kale  
KA12

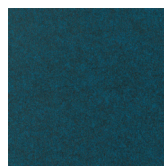

Denim  
DE09



Granite  
GR62

Order samples at [acoufelt.com/colorways](https://acoufelt.com/colorways)



Call 800.966.8557 with questions or visit [acoufelt.com](https://acoufelt.com) for more product information, downloads, and colorways.

# Sizes

<b>Standard Sizes</b>	48" W x 110" H Geometry pattern, 108" H
<b>Thickness</b>	1/2", 8mm (±10%) range to 1", 24mm (±10%)

**Plan**

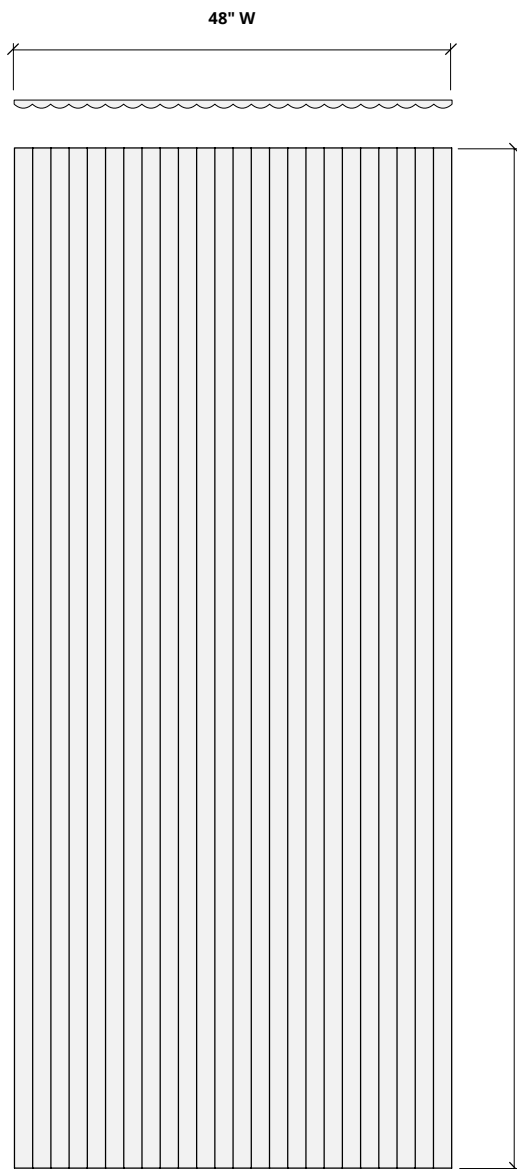

**Perspective**

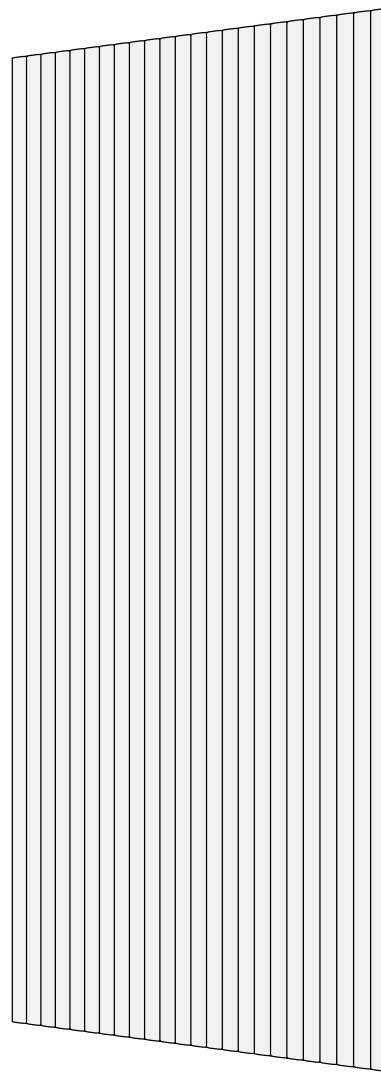

# How to Specify

## 1. Choose Panel Pattern

## 2. Choose Colorways

Select desired panel pattern. See recommended layouts for larger designs.

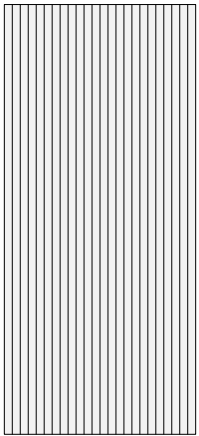

CELESTIAL A

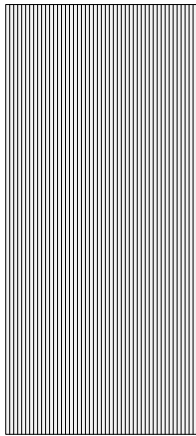

CELESTIAL B

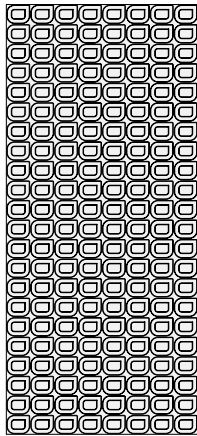

DEWDROPS

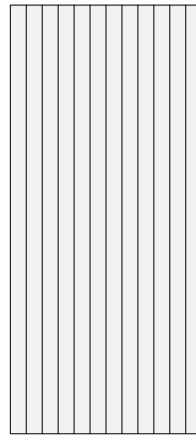

FENCE

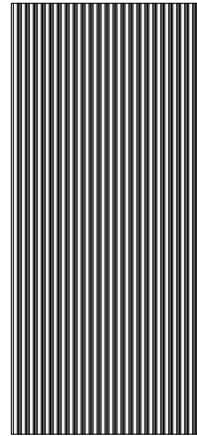

FURROWED

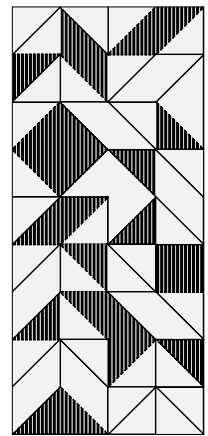

GEOMETRY

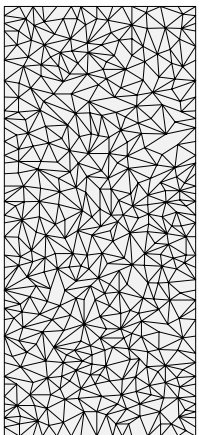

KALOS

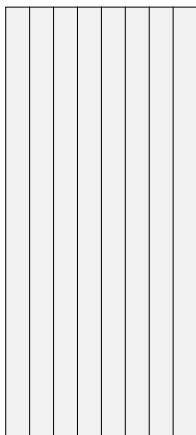

PATHWAY

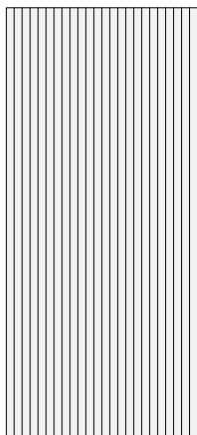

RIBBED A

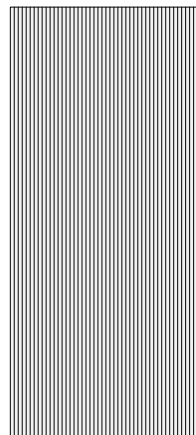

RIBBED B

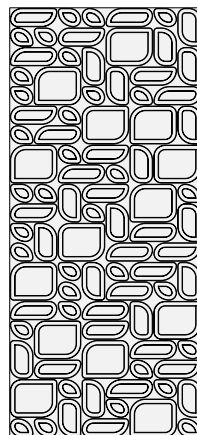

STONEWALL

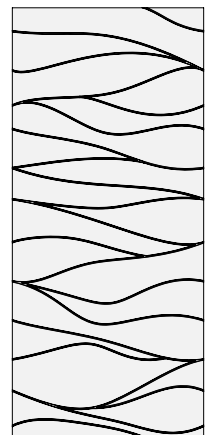

STREAM

## 1. Choose Panel Pattern

## 2. Choose Colorways

See colorways on page 3.



Call **800.966.8557** with questions or visit **acoufelt.com** for more product information, downloads, and colorways.

# Mounting Methods

## Construction adhesive

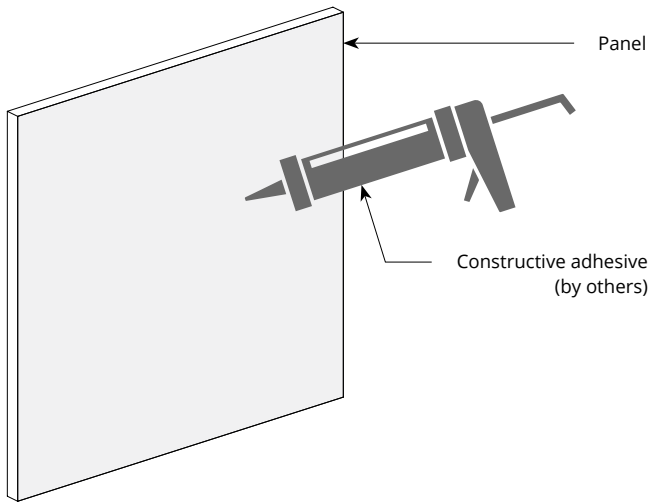

## Z-clip wall mount

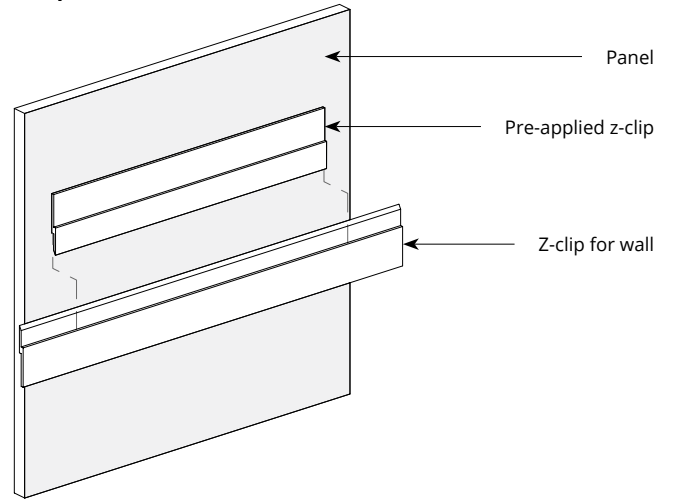

*\* For wall mount applications only.*



Call **800.966.8557** with questions or visit **acoufelt.com** for more product information, downloads, and colorways.

# Acoustic Performance

<b>Test Method</b>	ISO 354-2006
<b>Install Method</b>	A
<b>Rating Method</b>	ISO 11654-2002
<b>Test Results</b>	NRC 0.45, no air gap NRC 0.60, 20mm air gap NRC 0.75, 50mm air gap SAA 0.43, no air gap SAA 0.61, 20mm air gap SAA 0.72, 50mm air gap

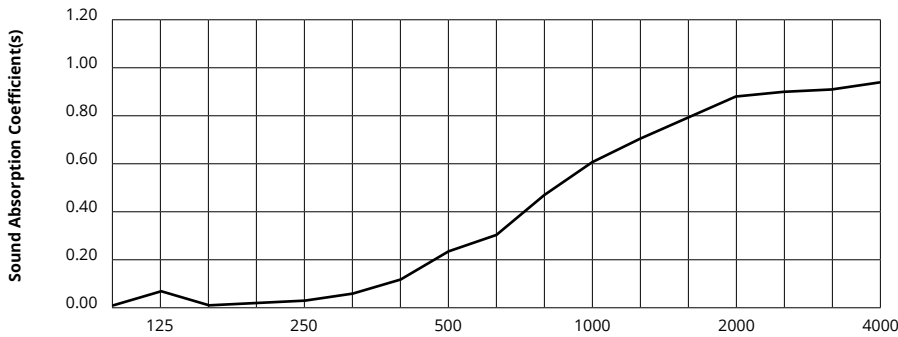

Frequency f (Hz)	125	250	500	1000	2000	4000	NRC
12mm	0.06	0.02	0.23	0.61	0.89	0.95	0.45

## What is a Noise Reduction Coefficient (NRC)?

You'll find the NRC rating in the specifications of all of our products. This acronym stands for Noise Reduction Coefficient, and is expressed as a single number, a rating that describes the degree to which acoustic products can absorb sound.

You can use NRC values to understand the overall performance of our acoustic wall and ceiling products. The higher the NRC, the better the product is at soaking up the sound.

*Performance Indices: Noise Reduction Coefficient (NRC) results represent the absorption coefficients measured at the one third octave bands at 125, 250, 500, 1000, 2000 and 4000 Hz rounded to the nearest 0.05. Acoustic testing has been performed according to the methods mentioned above. Customization of installation of the product could alter the results. Sound Absorption Average (SAA) indicates the absorption coefficient average for the twelve one-third octave bands ranging between 200 and 2500 Hz.*