

SoftenUp, Peak Wall Panels

Premier Collection

SoftenUp™ wall panels enhance any space with a warm, polished look, effectively reducing unwanted noise while hiding wall seams and imperfections. The Peak design features angular linear slats for a contemporary touch and comes in a variety of colors to complement any décor. Designed for effortless installation, SoftenUp panels offer a stylish and versatile acoustic wall solution for any environment.

Specifications

Surface	Wall	
Material	FilaSorb™ polyester felt	
Thickness	1/2", 12mm (±10%)	
Weight	0.49 lb./ft ² (±10%)	
Standard Sizes	Slat Profiles	Backer Panels
	2" T x 3" D	24" W x 24" H 24" W x 48" H 24" W x 96" H 24" W x 108" H

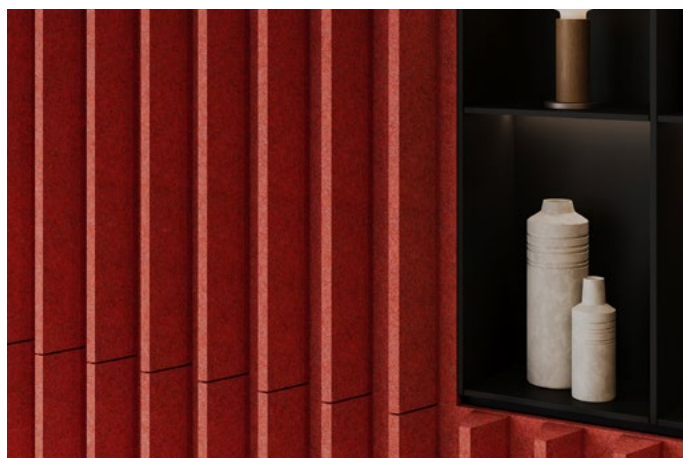

SoftenUp, Peak Wall Panels in Currant

Technical

NRC Rating	0.95 0.95, 5mm air gap 1.00, 12mm air gap 1.00, 3/4" air gap
Fire Test	ASTM E84, Class A Flame spread index: 15 Smoke developed index: 200
Water Sorption	ASTM C1104-2019 (A Modified) Water sorbed by weight: 0.20% (based on a 12mm thick panel)
Colorfastness	ISO 105-B02, 6-7

Details

Lead Time	3 – 6 weeks
Origin	Manufactured and assembled in the US
Warranty	Product: 20 years* Colorfastness: 20 years*

* Conditions apply

Environmental

Recycled Content	Minimum 60%
Energy	Generated using 40% solar energy
Indoor Air Quality	VOC less than/equal to 0.5mg/m ³
Recyclable	100%*
Certifications	Declare Certification - LBC Red List Free (third-party verified) SCS Global Indoor Advantage Gold

* PET is recyclable through participating partners.



Colorways

PREMIER



White
WH12

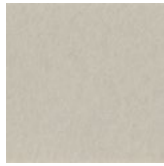

Almond
AL55



Celery
CE65



Sencha
SE58



Metal
ME03



Flamingo
FL61

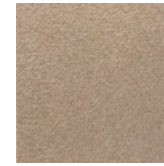

Quartz
QU67

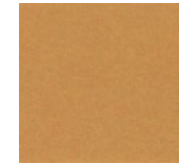

Turmeric
TU60



Platinum
PL04

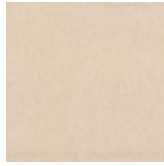

Pearl
PE21



Pistachio
PI25

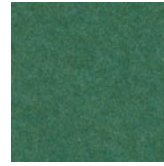

Thistle
TH28

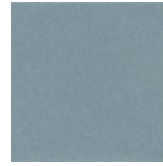

Stonewash
ST72

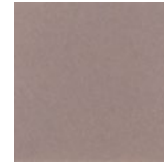

Amethyst
AM69



Valentine
VA70

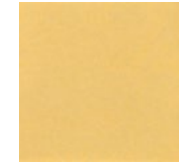

Wheat
WH68

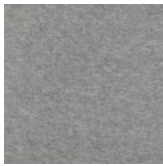

Grey
GR02



Ivory
IV11

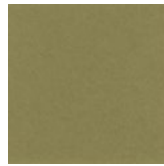

Eucalyptus
EU71



Peacock
PE20



Periwinkle
PE23



Lilac
LI13



Peach
PE19

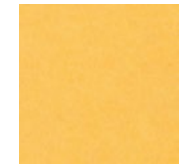

Popcorn
PO26

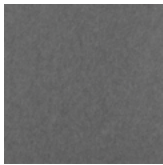

Slate
SL27

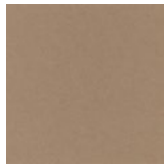

Umber
UM54

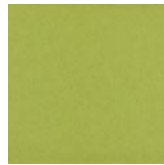

Wasabi
WA29

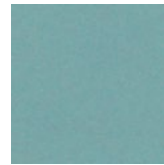

Sea Salt
SE57

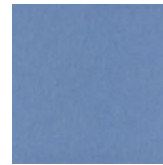

Marine
MA15



Berry
BE06

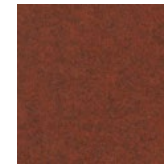

Peppercorn
PE22



Carrot
CA08

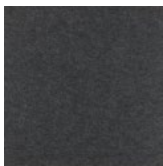

Charcoal
CH01

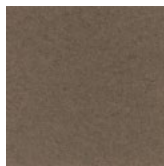

Walnut
WA56

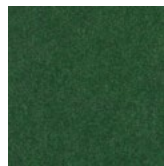

Oregano
OR18

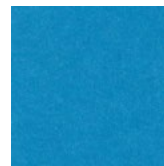

Azure
AZ05

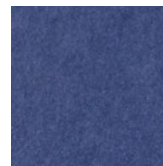

Iris
IR10

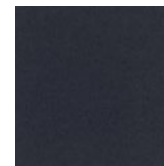

Flint
FL64

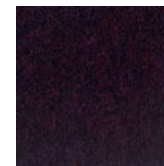

Shiraz
SH63

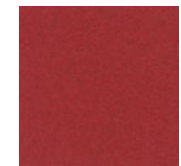

Currant
CU59

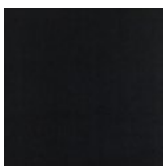

Piano Black
PI24

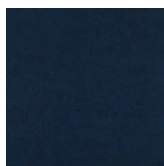

Midnight
MI16

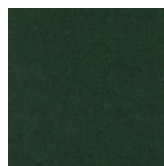

Kale
KA12

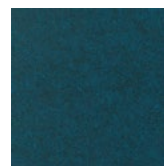

Denim
DE09

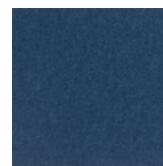

Granite
GR62

Order samples at acoufelt.com/colorways



Call 800.966.8557 with questions or visit acoufelt.com for more product information, downloads, and colorways.

How to Specify

1. Choose Slat Size

2. Choose Backer Panel Size

3. Choose Colorways

Slats are available in one size:

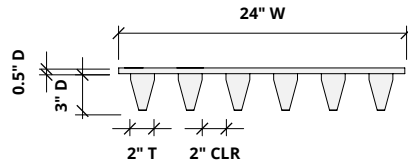
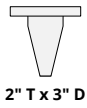

1. Choose Slat Size

2. Choose Backer Panel Size

3. Choose Colorways

Backer panels are available in four heights: 24, 48, 96 and 108" H.

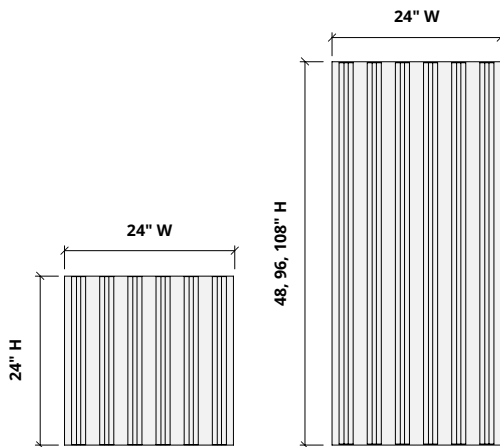

1. Choose Slat Size

2. Choose Backer Panel Size

3. Choose Colorways

Select one colorway for your slats and one colorway for your backer panel.
See colorway choices on page 3.

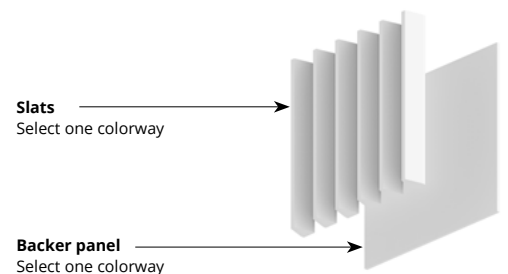

Mounting Methods

Adhesive backing

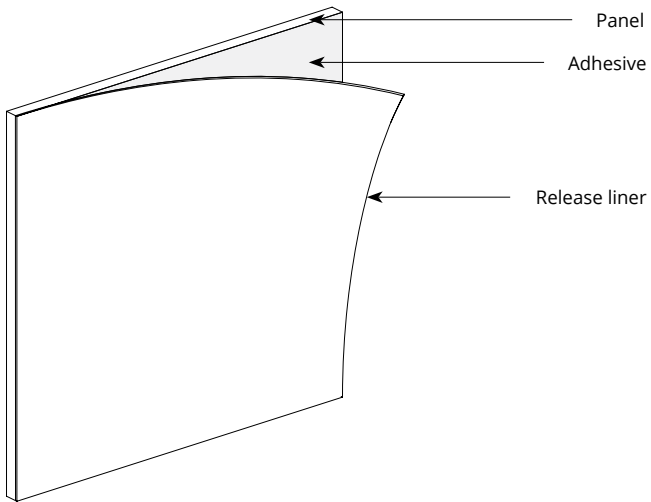

Construction adhesive

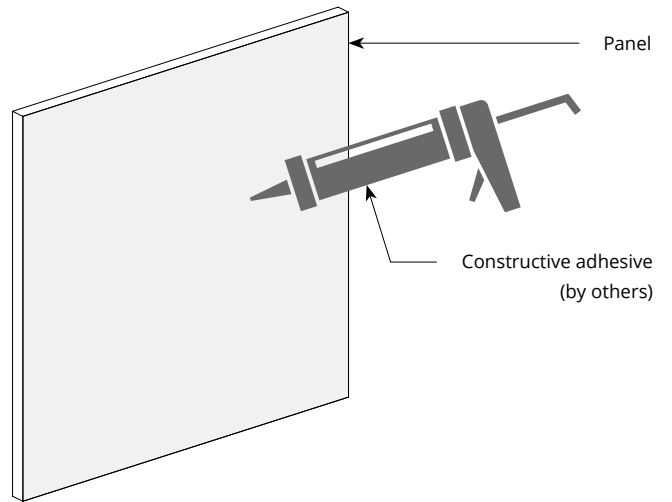

Z-clip wall mount

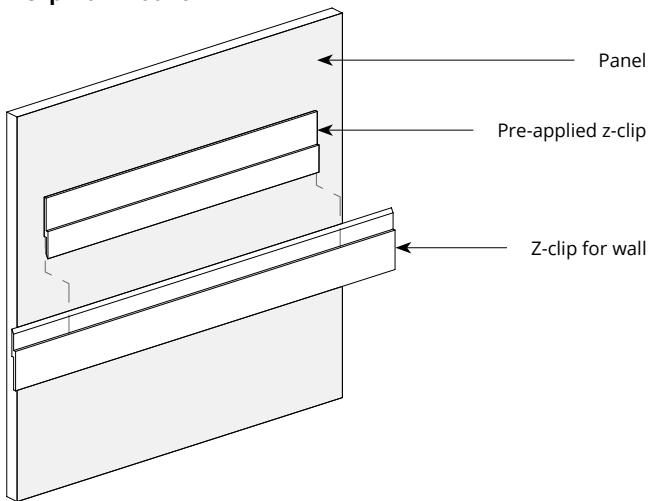

* For wall mount applications only.



Call **800.966.8557** with questions or visit **acoufelt.com** for more product information, downloads, and colorways.

Acoustic Performance

Test Method	ASTM E795
Install Method	Type E-400
Rating Method	ASTM C423
Mounting Method	2" T x 3" D slat on 12mm backer
Test Results	<p>NRC 0.95</p> <p>NRC 0.95, 5mm air gap</p> <p>NRC 1.00, 12mm air gap</p> <p>NRC 1.00, 3/4" air gap</p> <p>SAA 0.95, no air gap</p> <p>SAA 0.97, 5mm air gap</p> <p>SAA 1.00, 12mm air gap</p> <p>SAA 1.01, 3/4" air gap</p>

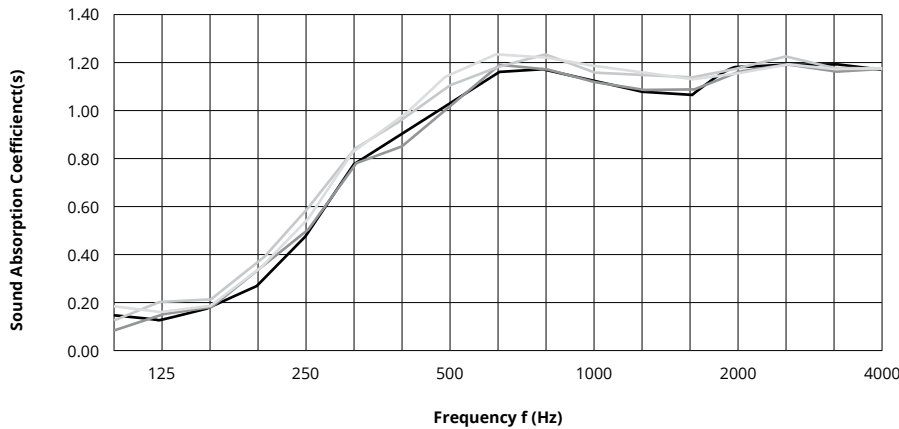

	Frequency f (Hz)	125	250	500	1000	2000	4000	NRC
	12mm	0.17	0.49	1.03	1.12	1.17	1.16	0.95
	12mm, 5mm air gap	0.19	0.53	1.03	1.13	1.17	1.18	0.95
	12mm, 12mm air gap	0.15	0.22	1.10	1.15	1.16	1.16	1.00
	12mm, 3/4" air gap	0.27	0.59	1.13	1.17	1.14	1.16	1.00

What is a Noise Reduction Coefficient (NRC)?

You'll find the NRC rating in the specifications of all of our products. This acronym stands for Noise Reduction Coefficient, and is expressed as a single number, a rating that describes the degree to which acoustic products can absorb sound.

You can use NRC values to understand the overall performance of our acoustic wall and ceiling products. The higher the NRC, the better the product is at soaking up the sound.

Performance Indices: Noise Reduction Coefficient (NRC) results represent the absorption coefficients measured at the one third octave bands at 125, 250, 500, 1000, 2000 and 4000 Hz rounded to the nearest 0.05. Acoustic testing has been performed according to the methods mentioned above. Customization of installation of the product could alter the results. Sound Absorption Average (SAA) indicates the absorption coefficient average for the twelve one-third octave bands ranging between 200 and 2500 Hz.