



Horizon, Desert Ceiling Frames

WoodGrain Collection

Look up to a peaceful vista. Evenly arranged horizon cubes mimic a calming, open expanse of land while ensuring superior sound management. Choose a single Premier color or WoodGrain option or select two complementary finishes for the cubes and the backing. Modern, modular, and easy to mount with T-grid clips, Horizon can change your outlook about working or meeting in a crowded space.

Specifications

Surface	Ceiling	
Material	FilaSorb™ polyester felt	
Thickness	1/2", 12mm (±10%)	
Weight	0.49 lb./ft ² (±10%)	
Standard Sizes	Height	Backer Panels
	3, 6" H	24" W x 24" L
Compatible T-grid	Type	Layout
	15/16" Flat	Standard 24" x 24"
	9/16" Flat	Standard 24" x 24"



Horizon, Desert Ceiling Frames in Scorched Timber

Technical

NRC Rating	Pending product testing
Fire Test	ASTM E84, Class A Flame spread index: 15 Smoke developed index: 200
Water Sorption	ASTM C1104-2019 (A Modified) Water sorbed by weight: 0.20% (based on a 12mm thick panel)
Colorfastness	ISO 105-B02, 6-7

Details

Lead Time	3 – 6 weeks
Origin	Manufactured and assembled in the US
Warranty	Product: 20 years* Colorfastness: 20 years*

* Conditions apply

Environmental

Recycled Content	Minimum 60%
Energy	Generated using 40% solar energy
Indoor Air Quality	VOC less than/equal to 0.5mg/m ³
Recyclable	100%*
Certifications	Declare Certification - LBC Red List Free (third-party verified) SCS Global Indoor Advantage Gold

* PET is recyclable through participating partners.



Sizes

Standard Heights	3, 6" H
Standard Widths	24" W
Thickness	1/2", 12mm (±10%)

Standard Length 24" L

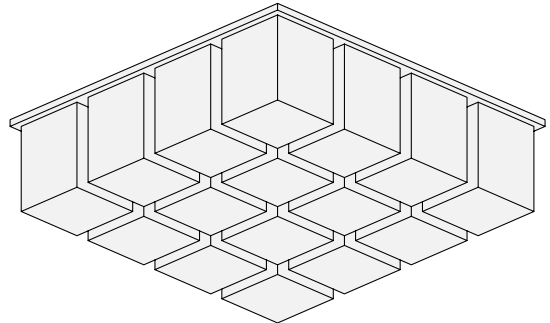
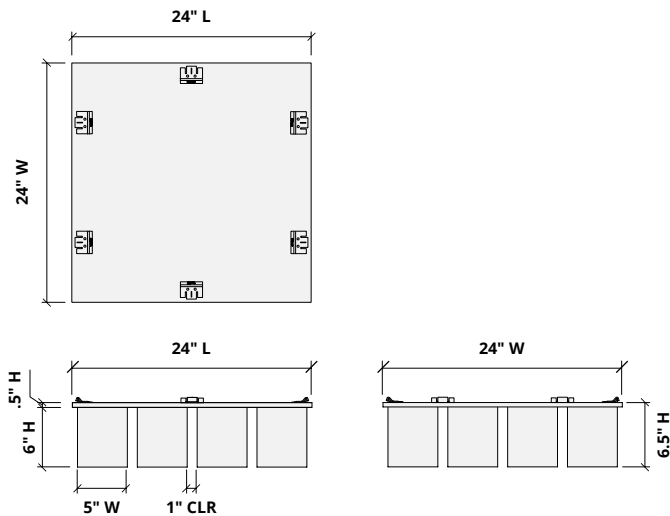
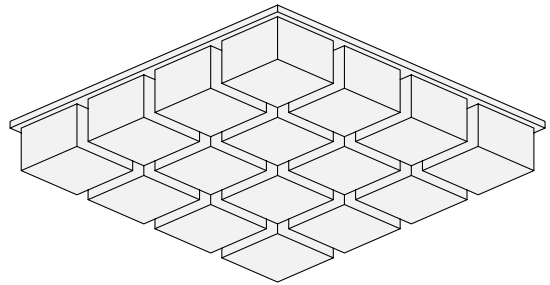
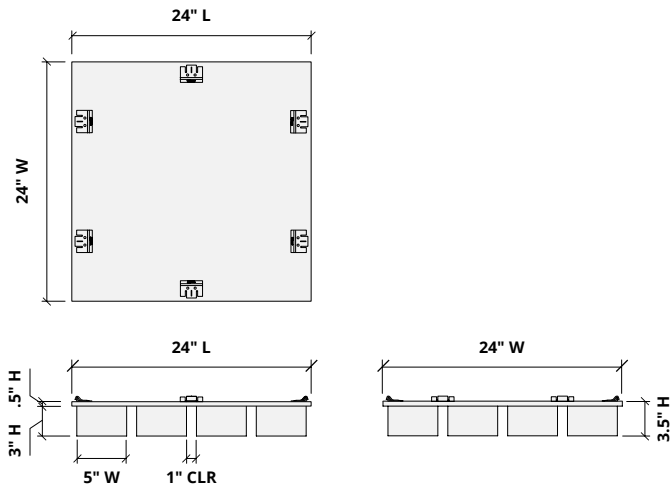

Choose Colorways

Select one colorway for your slats and one colorway for your backer panel; or one colorway for both. See colorway choices on page 4.

If you're specifying dark colored backer panels, we recommend dark drop ceiling grids (not provided).

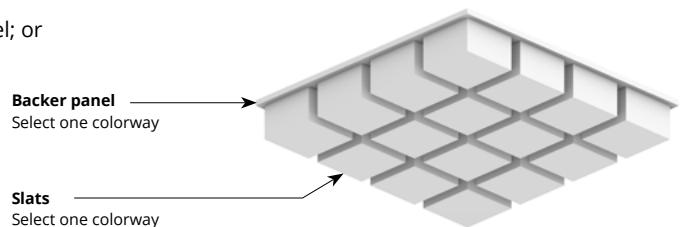

Colorways

WOODGRAIN



Boat Shed
WQ02



Picket Fence
WQ01



Loft
WQ06

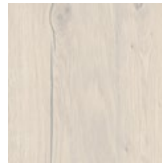

Nordic Plank
WQ15



White Oak
WQ13



Baltic Birch
WQ12



White Elm
WQ07

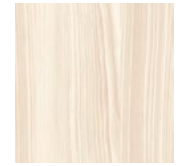

Lyed Larch
WQ30



Woodland Fog
WQ22



Weathered Slate
WQ14

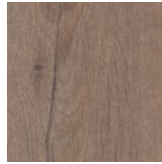

French Bobbin
WQ08

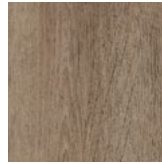

Boardwalk
WQ10

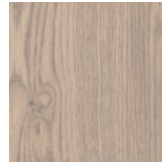

Mountain Lodge
WQ24

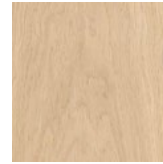

Wine Barrel
WQ03



Natural Oak
WQ16



Knotty Spruce
WQ29



Shadow Oak
WQ28

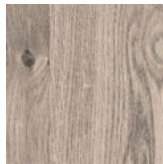

Driftwood
WQ21

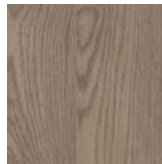

Mocha Legno
WQ25

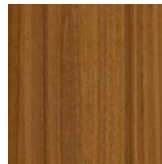

Teak
WQ18



Fumed Oak
WQ19

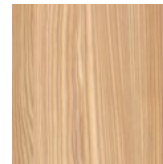

European Larch
WQ17



Petrified Ash
WQ23

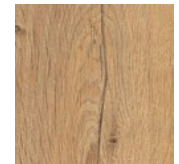

Log Cabin
WQ04

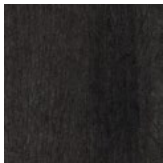

Charred Larch
WQ09

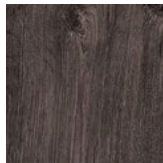

Barn Door
WQ05

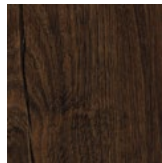

Antique Chest
WQ11

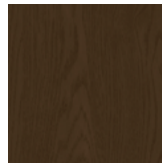

Scorched Timber
WQ26

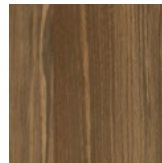

Espresso Oak
WQ27

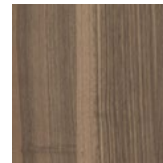

Black Walnut
WQ20

Order samples at acoufelt.com/colorways

Lighting Coordination

24" x 24", 24" x 48" Grid light

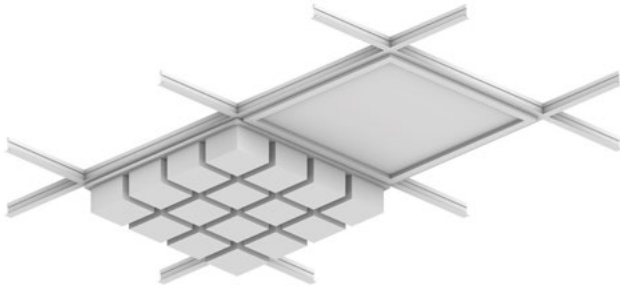

Drop pendant light

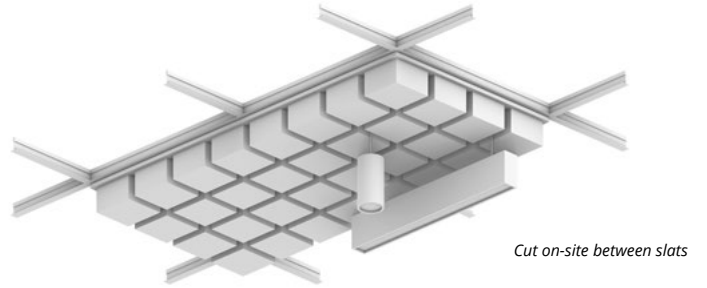

Recessed light

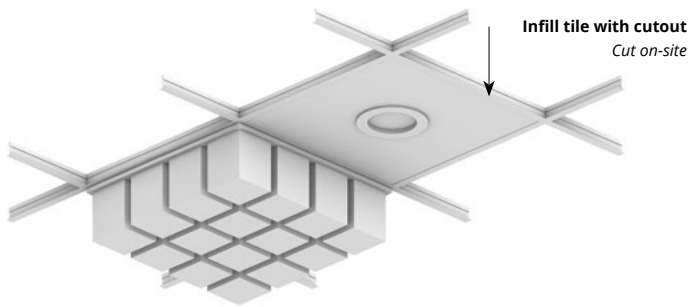

Grid mounted light (track, pendant)

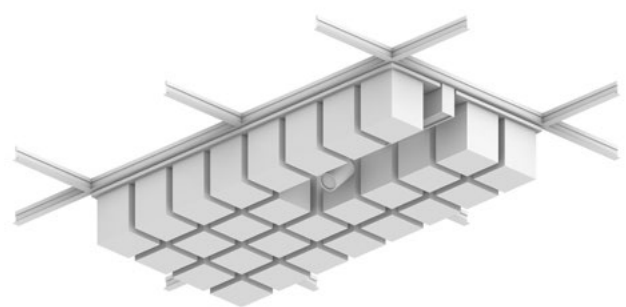

Recommended Layout

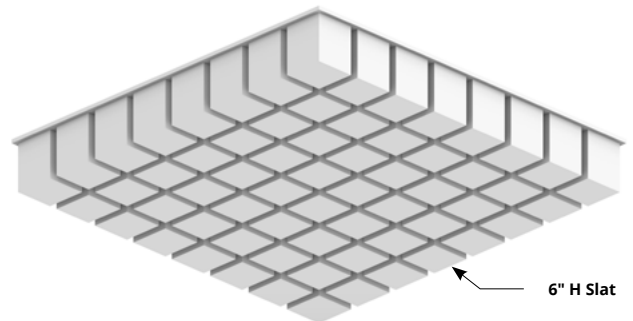
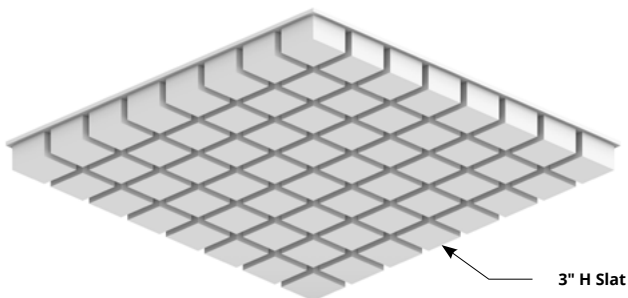

Acoustic Performance

Test Method	ASTM E795
Install Method	Type E-400
Rating Method	ASTM C423
Mounting Method	2" W x 3" H slat on 12mm backer with 400mm air gap
Test Results	NRC 0.95 SAA 0.96

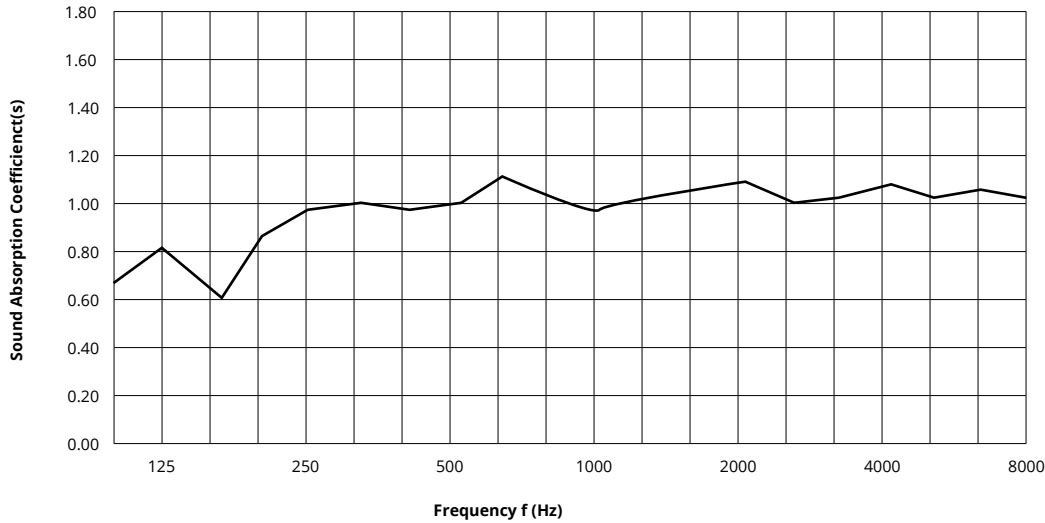

Frequency f (Hz)	125	250	500	1000	2000	4000	NRC
12mm	0.67	0.86	0.96	1.02	1.04	1.00	0.95

What is a Noise Reduction Coefficient (NRC)?

You'll find the NRC rating in the specifications of all of our products. This acronym stands for Noise Reduction Coefficient, and is expressed as a single number, a rating that describes the degree to which acoustic products can absorb sound.

You can use NRC values to understand the overall performance of our acoustic wall and ceiling products. The higher the NRC, the better the product is at soaking up the sound.

Performance Indices: Noise Reduction Coefficient (NRC) results represent the absorption coefficients measured at the one third octave bands at 125, 250, 500, 1000, 2000 and 4000 Hz rounded to the nearest 0.05. Acoustic testing has been performed according to the methods mentioned above. Customization of installation of the product could alter the results. Sound Absorption Average (SAA) indicates the absorption coefficient average for the twelve one-third octave bands ranging between 200 and 2500 Hz.