



## Framework, Frameless Ceiling Grids

Premier Collection

Often less is more. Frameless's design provides an open ceiling aesthetic while delivering the perfect amount of sound-absorbing surface area for spaces where some noise is expected and acceptable. With an expansive offering of different thicknesses and heights, Frameless can be specified to be unique in different spaces. The Frameless design allows the utmost flexibility when installed around other ceiling components such as sprinklers, speakers, and lighting.

## Specifications

<b>Surface</b>	Ceiling		
<b>Material</b>	FilaSorb™ polyester felt		
<b>Thickness</b>	1/2", 12mm (±10%)		
<b>Weight</b>	0.49 lb./ft <sup>2</sup> (±10%)		
<b>Standard Sizes</b>	<b>Cell</b>	<b>Height</b>	<b>Thickness</b>
	2' x 2'	6, 8, 10,	2, 3, 4" T
	3' x 3'	or 12" H	
	4' x 4'		
<i>Custom sizes available</i>			



Framework, Frameless in Pistachio

## Technical

<b>NRC Rating</b>	1.65
<b>Fire Test</b>	ASTM E84, Class A Flame spread index: 15 Smoke developed index: 200
<b>Water Sorption</b>	ASTM C1104-2019 (A Modified) Water sorbed by weight: 0.20% (based on a 12mm thick panel)
<b>Colorfastness</b>	ISO 105-B02, 6-7

## Details

<b>Lead Time</b>	3 – 6 weeks
<b>Origin</b>	Manufactured and assembled in the US
<b>Warranty</b>	Product: 20 years* Colorfastness: 20 years*

\* Conditions apply

## Environmental

<b>Recycled Content</b>	Minimum 60%
<b>Energy</b>	Generated using 40% solar energy
<b>Indoor Air Quality</b>	VOC less than/equal to 0.5mg/m3
<b>Recyclable</b>	100%*
<b>Certifications</b>	Declare Certification - LBC Red List Free (third-party verified) SCS Global Indoor Advantage Gold

\* PET is recyclable through participating partners.



# Colorways

## PREMIER

							
White WH12	Almond AL55	Celery CE65	Sencha SE58	Metal ME03	Flamingo FL61	Quartz QU67	Turmeric TU60
							
Platinum PL04	Pearl PE21	Pistachio PI25	Thistle TH28	Stonewash ST72	Amethyst AM69	Valentine VA70	Wheat WH68
							
Grey GR02	Ivory IV11	Eucalyptus EU71	Peacock PE20	Periwinkle PE23	Lilac LI13	Peach PE19	Popcorn PO26
							
Slate SL27	Umber UM54	Wasabi WA29	Sea Salt SE57	Marine MA15	Berry BE06	Peppercorn PE22	Carrot CA08
							
Charcoal CH01	Walnut WA56	Oregano OR18	Azure AZ05	Iris IR10	Flint FL64	Shiraz SH63	Currant CU59
							
Piano Black PI24	Midnight MI16	Kale KA12	Denim DE09	Granite GR62			

Order samples at [acoufelt.com/colorways](https://acoufelt.com/colorways)



Call 800.966.8557 with questions or visit [acoufelt.com](https://acoufelt.com) for more product information, downloads, and colorways.

# Sizes

Standard Sizes	Cell	Height	Thickness
	2' x 2'	6, 8, 10,	2, 3, 4" T
	3' x 3'	or 12" H	
	4' x 4'		

*Custom sizes available*

## Plans

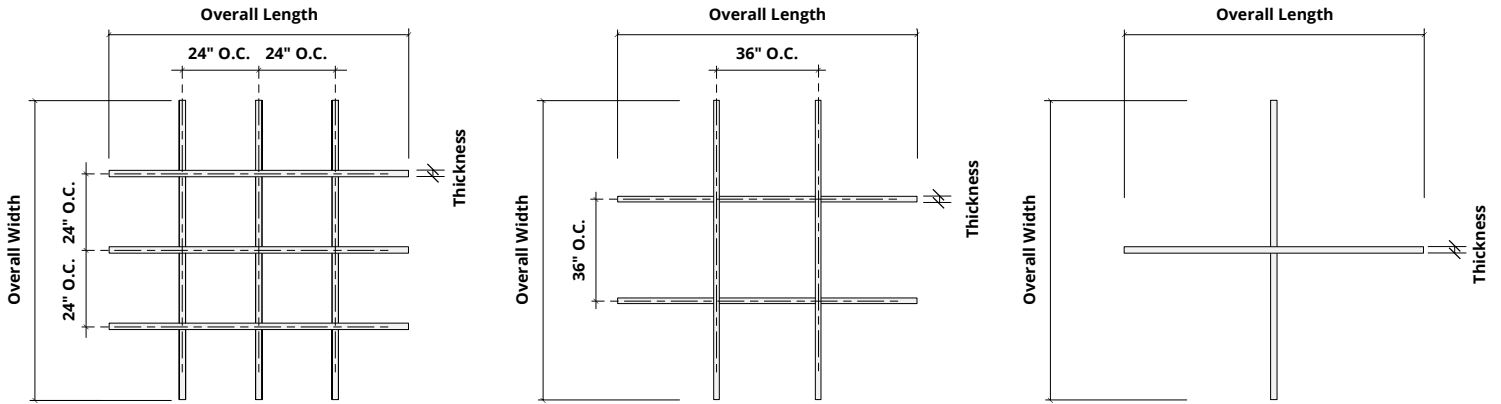

## Elevations

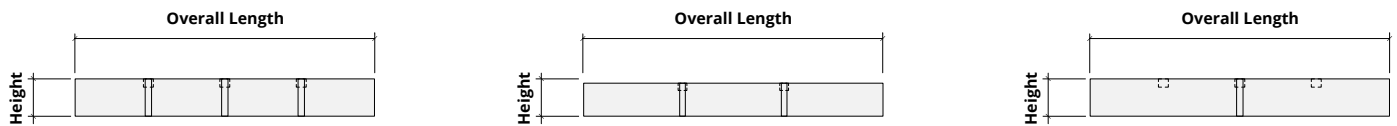

## Perspectives



# How to Specify

## 1. Choose Grid Size

## 2. Choose Slat Sizes

## 3. Choose Colorways

Grids are available in three size: 2' x 2', 3' x 3', and 4' x 4'.

2' x 2'



3' x 3'



4' x 4'

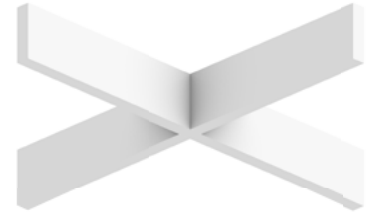

## 1. Choose Grid Size

## 2. Choose Slat Sizes

## 3. Choose Colorways

Slats are available in 2 size options.

### A: Consistent Sizes



Slat Size
2" T x 6" H
2" T x 8" H
2" T x 10" H
2" T x 12" H
3" T x 6" H
3" T x 8" H
3" T x 10" H
3" T x 12" H
4" T x 6" H
4" T x 8" H
4" T x 10" H
4" T x 12" H

### B: Varied Sizes

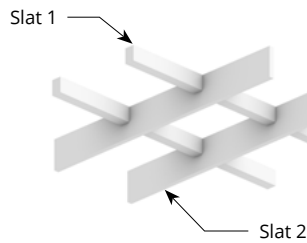

Height ratio from Slat 1 to Slat 2 is 2:1

Slat 1 Size	Slat 2 Size
2" T x 3" H	2" T x 6" H
2" T x 4" H	2" T x 8" H
2" T x 5" H	2" T x 10" H
2" T x 6" H	2" T x 12" H
3" T x 3" H	3" T x 6" H
3" T x 4" H	3" T x 8" H
3" T x 5" H	3" T x 10" H
3" T x 6" H	3" T x 12" H
4" T x 3" H	4" T x 6" H
4" T x 4" H	4" T x 8" H
4" T x 5" H	4" T x 10" H
4" T x 6" H	4" T x 12" H
2" T x 3" H	4" T x 6" H
2" T x 4" H	4" T x 8" H
2" T x 5" H	4" T x 10" H
2" T x 6" H	4" T x 12" H
4" T x 3" H	2" T x 6" H
4" T x 4" H	2" T x 8" H
4" T x 5" H	2" T x 10" H
4" T x 6" H	2" T x 12" H

## 1. Choose Slat Size

## 2. Choose Backer Panel Size

## 3. Choose Colorways

See colorway choices on the page 3.



Call 800.966.8557 with questions or visit [acoufelt.com](http://acoufelt.com) for more product information, downloads, and colorways.

# Hardware Spacing

2' x 2'	24" on center spacing
3' x 3'	36" on center spacing
4' x 4'	24" on center spacing

## Plans

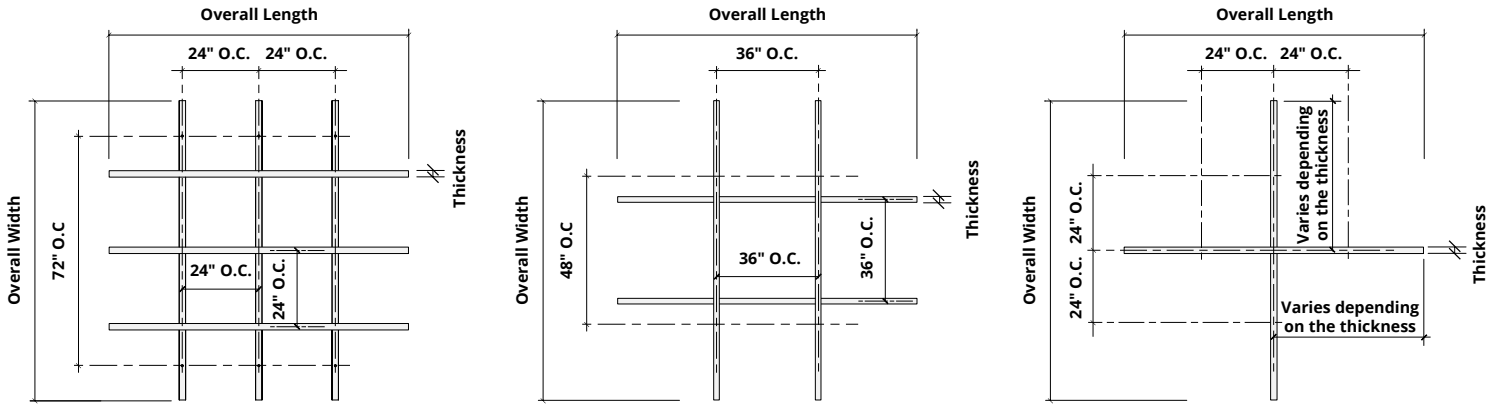

## Elevations

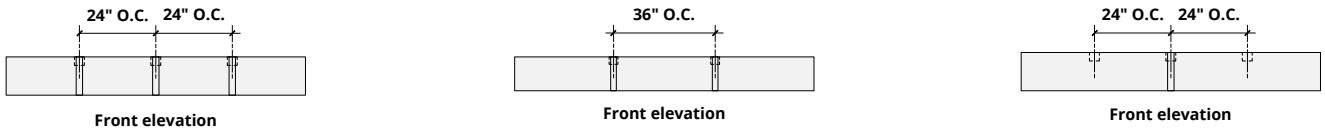

# Mounting Methods

## Cable

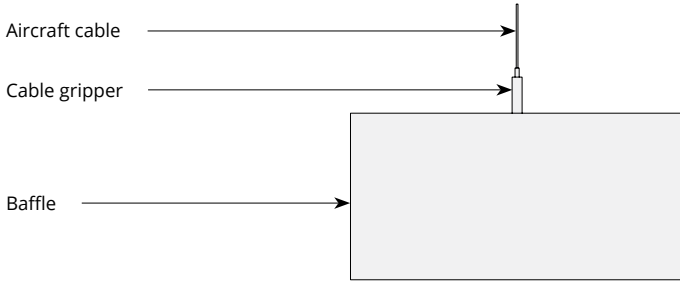

## Cable to deck

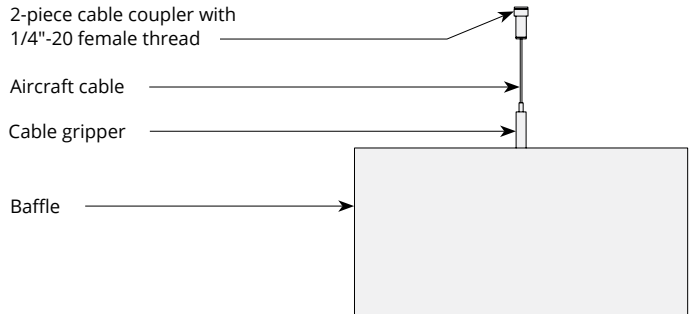

## Cable to T-grid

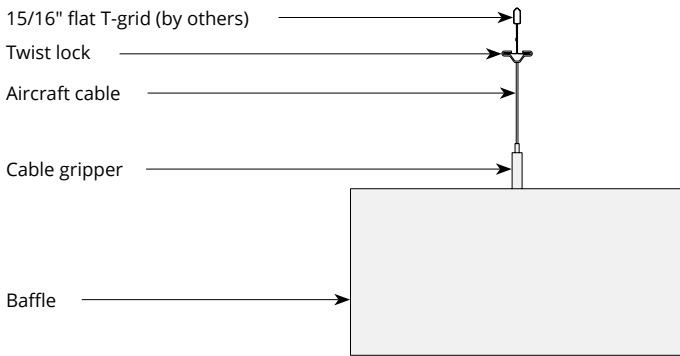

## Cable to Unistrut

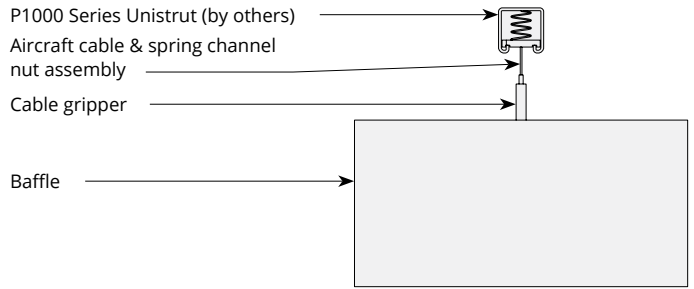

## Swivel cable to deck

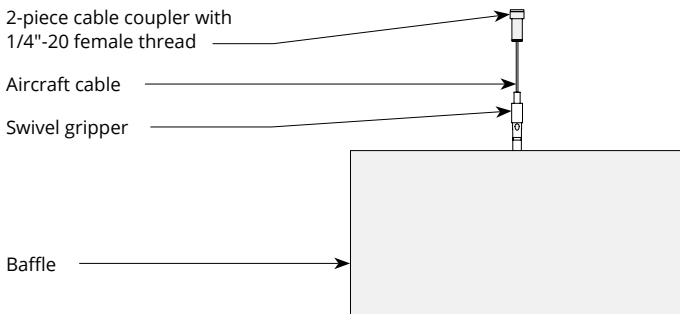

## Direct to Unistrut

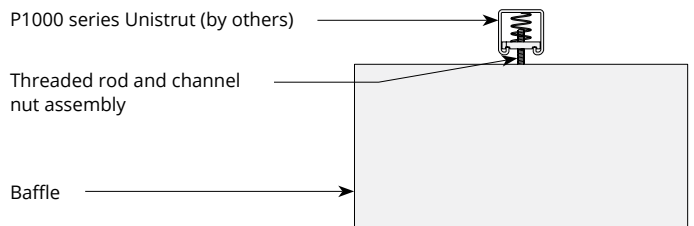

# Mounting Methods

## Twist lock to T-grid

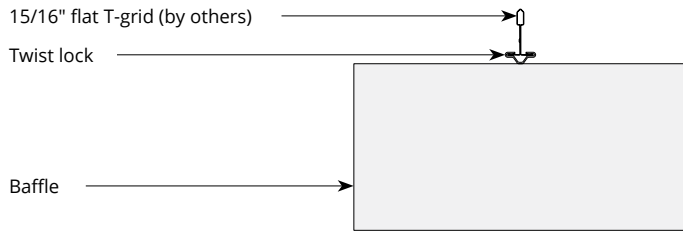



# Acoustic Performance

<b>Test Method</b>	ASTM E795-16
<b>Install Method</b>	J-600
<b>Rating Method</b>	ASTM C423-17
<b>Mounting Method</b>	Sample tested 6 baffles 110" L x 12" H x 3" T, hanging 600mm from floor and 152mm from each other
<b>Test Results</b>	NRC 1.65 SAA 1.68

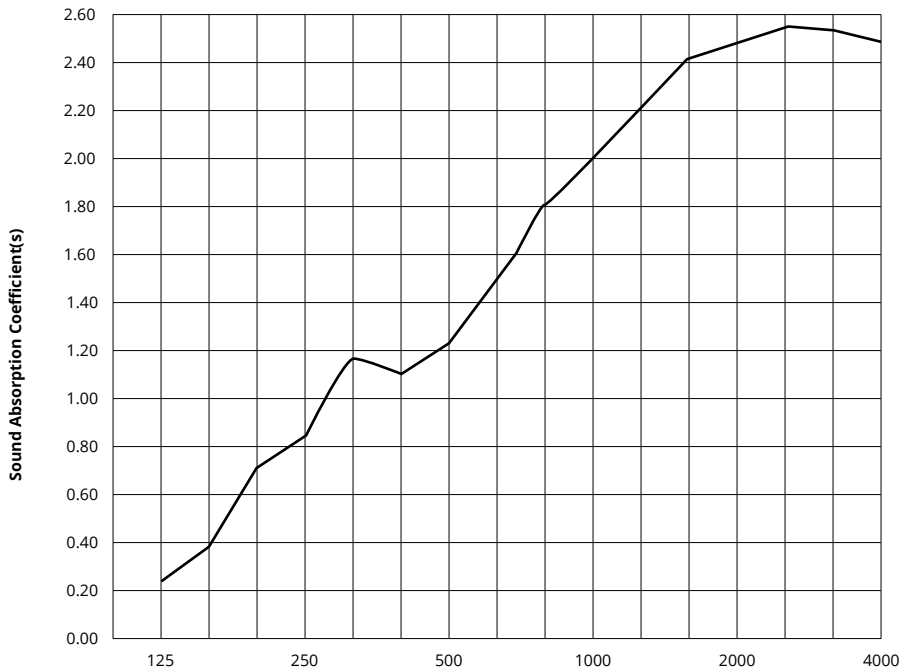

Frequency f (Hz)	125	250	500	1000	2000	4000	NRC
<b>3" Truss Baffle</b>	<b>0.26</b>	<b>0.86</b>	<b>1.25</b>	<b>2.02</b>	<b>2.49</b>	<b>2.49</b>	<b>1.65</b>

## What is a Noise Reduction Coefficient (NRC)?

You'll find the NRC rating in the specifications of all of our products. This acronym stands for Noise Reduction Coefficient, and is expressed as a single number, a rating that describes the degree to which acoustic products can absorb sound.

You can use NRC values to understand the overall performance of our acoustic wall and ceiling products. The higher the NRC, the better the product is at soaking up the sound.

*Performance Indices: Noise Reduction Coefficient (NRC) results represent the absorption coefficients measured at the one third octave bands at 125, 250, 500, 1000, 2000 and 4000 Hz rounded to the nearest 0.05. Acoustic testing has been performed according to the methods mentioned above. Customization of installation of the product could alter the results. Sound Absorption Average (SAA) indicates the absorption coefficient average for the twelve one-third octave bands ranging between 200 and 2500 Hz.*

