

Step Ceiling Baffles

WoodGrain Collection

A stair-step approach to providing movement, Step acoustic ceiling baffles provide plenty of areas to capture unwanted sound. The series of six baffles installed in various sequences provide interesting textural effects.

Specifications

Surface	Ceiling
Material	FilaSorb™ polyester felt
Thickness	1/2", 12mm (±10%)
Weight	0.49 lb./ft ² (±10%)
Standard Sizes	Height A: 6, 8, 10, 12" H Height B: 3, 4, 5, 6" H Depth: 1, 2" D Lengths: Range from 12" up to 110" L <i>See page 4 for more details. Custom sizes available</i>

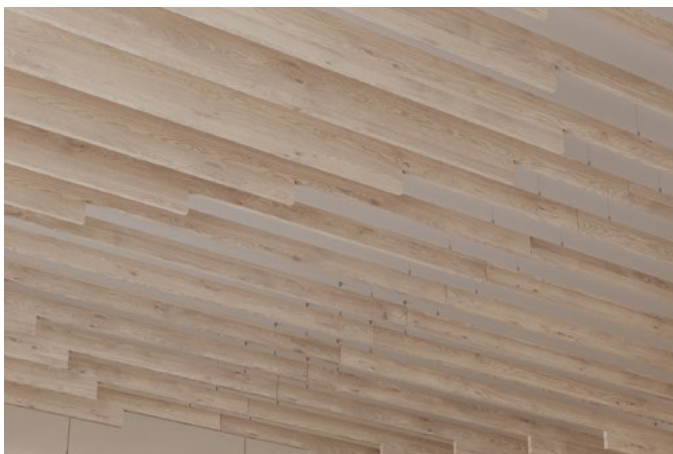

Step Ceiling Baffle in Mountain Lodge

Technical

NRC Rating	1.30
Fire Test	ASTM E84, Class A Flame spread index: 15 Smoke developed index: 200
Water Sorption	ASTM C1104-2019 (A Modified) Water sorbed by weight: 0.20% (based on a 12mm thick panel)
Colorfastness	ISO 105-B02, 6-7

Details

Lead Time	3 – 6 weeks
Origin	Manufactured and assembled in the US
Warranty	Product: 20 years* Colorfastness: 20 years*

* Conditions apply

Environmental

Recycled Content	Minimum 60%
Energy	Generated using 40% solar energy
Indoor Air Quality	VOC less than/equal to 0.5mg/m3
Recyclable	100%*
Certifications	Declare Certification - LBC Red List Free (third-party verified) SCS Global Indoor Advantage Gold

* PET is recyclable through participating partners.



Colorways

WOODGRAIN



Boat Shed
WQ02

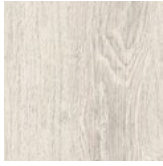

Picket Fence
WQ01

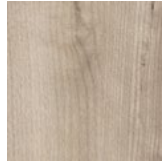

Loft
WQ06

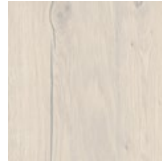

Nordic Plank
WQ15

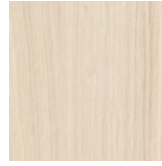

White Oak
WQ13



Baltic Birch
WQ12



White Elm
WQ07

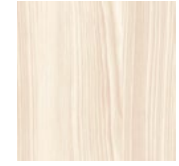

Lyed Larch
WQ30



Woodland Fog
WQ22



Weathered Slate
WQ14

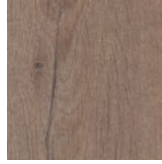

French Bobbin
WQ08

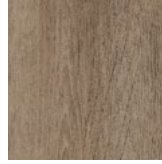

Boardwalk
WQ10

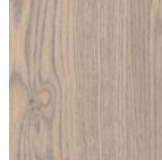

Mountain Lodge
WQ24

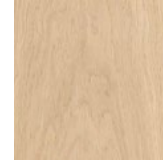

Wine Barrel
WQ03

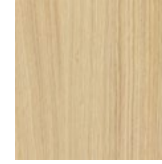

Natural Oak
WQ16

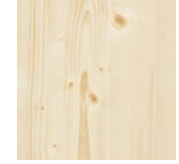

Knotty Spruce
WQ29



Shadow Oak
WQ28



Driftwood
WQ21

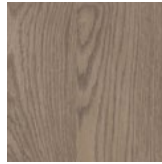

Mocha Legno
WQ25



Teak
WQ18

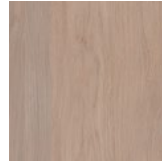

Fumed Oak
WQ19



European Larch
WQ17



Petrified Ash
WQ23

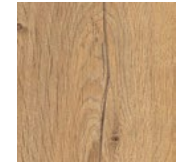

Log Cabin
WQ04



Charred Larch
WQ09



Barn Door
WQ05

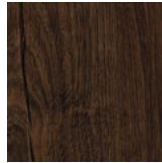

Antique Chest
WQ11

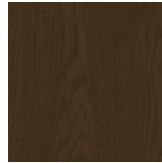

Scorched Timber
WQ26

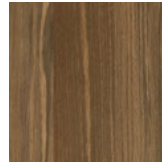

Espresso Oak
WQ27

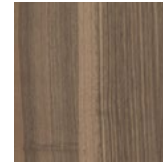

Black Walnut
WQ20

Order samples at acoufelt.com/colorways

Sizes

Height	Height A: 6, 8, 10, 12" H Height B: 3, 4, 5, 6" H
Depth	1, 2" D
Length	24, 30, 36, 42, 48, 54, 60, 66, 72, 78, 84, 90, 96, 102, 108, 110" L <i>Custom sizes available</i>
Thickness	1/2", 12mm (±10%)

Height A	Height B
6"	3"
8"	4"
10"	5"
12"	6"

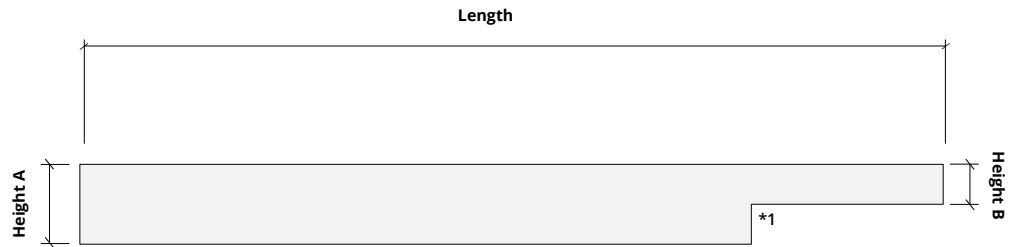

Perspective

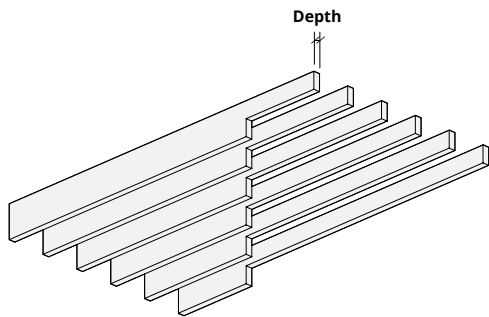

12mm
thickness

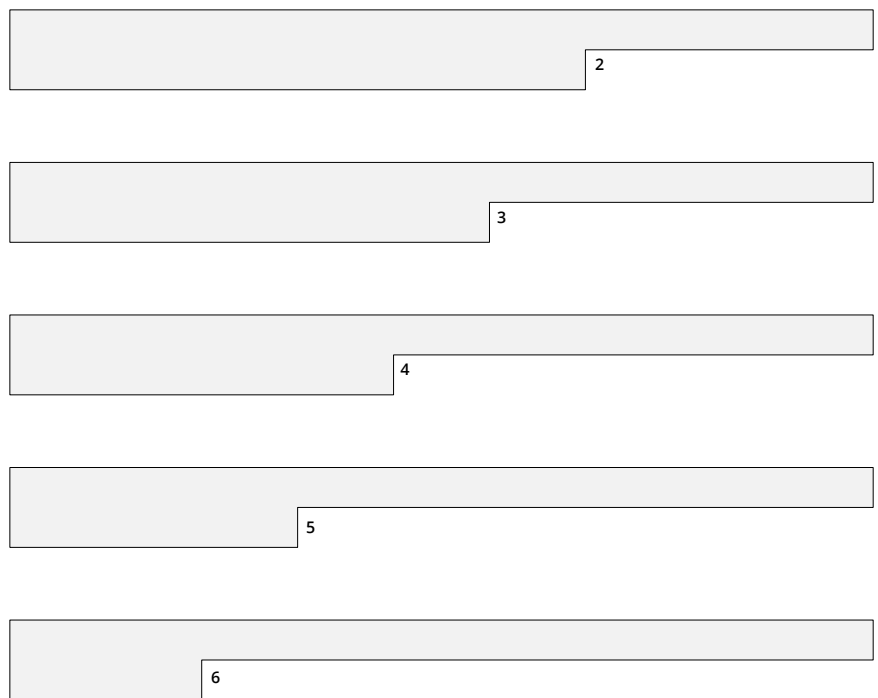

* Height range from A to B is 2:1; based on baffle number 1 in the sequence.
Refer to page 5 for baffle plan and sequences.

Recommended Layouts

Typical layout

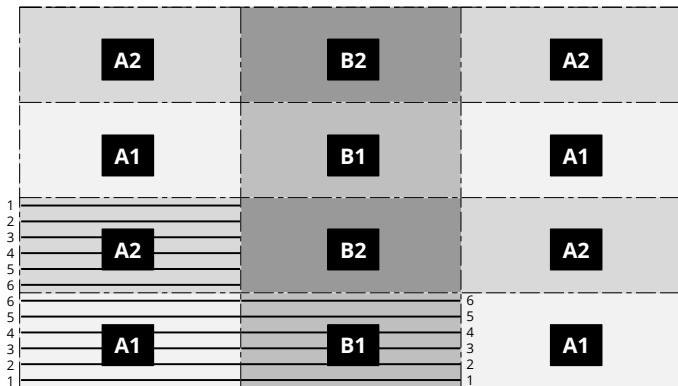

Module layouts

A1

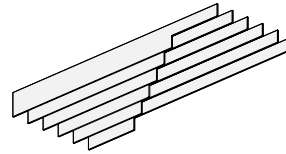

B1

Reflected direction of A1

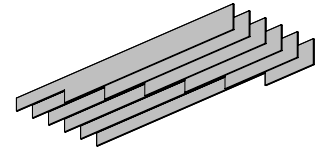

A2

Reverse order of A1

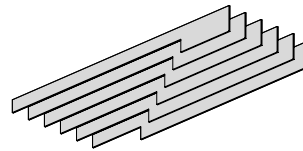

B2

Reverse order of B1

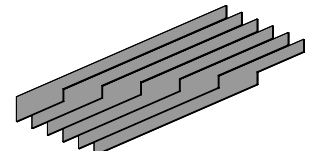

Perspective

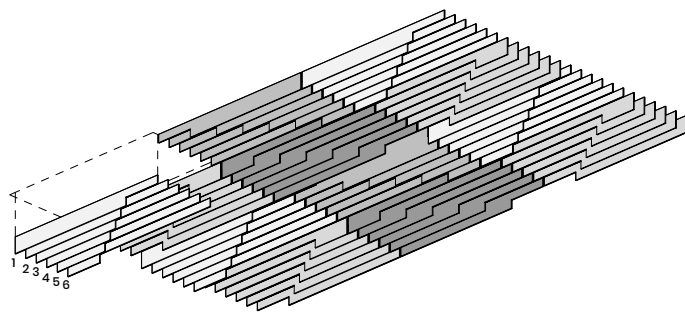

Front perspective

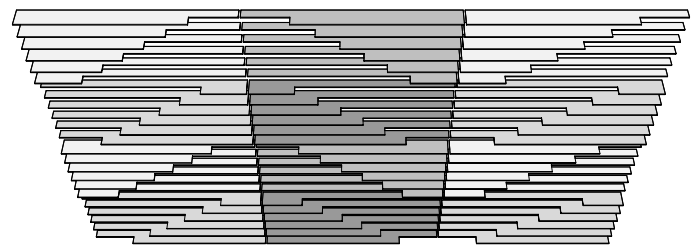

Hardware Spacing

12, 18" L	6" on center spacing
24, 30" L	12" on center spacing
36, 42, 48, 54" L	24" on center spacing
60, 66, 72, 78, 84, 90" L	24" on center spacing
96, 102, 108, 110" L	30" on center spacing

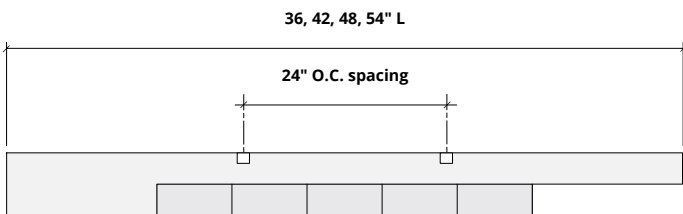
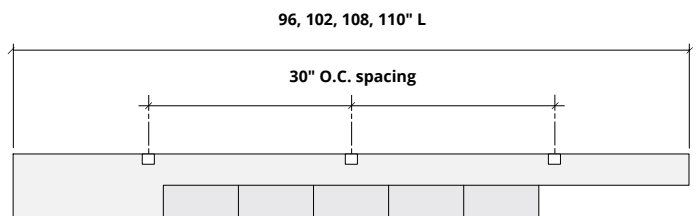
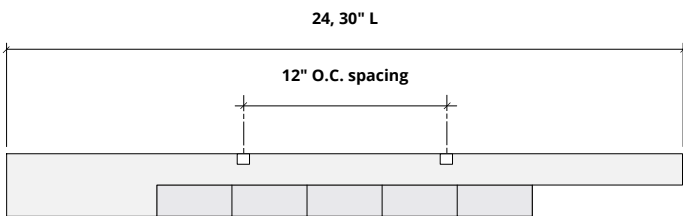
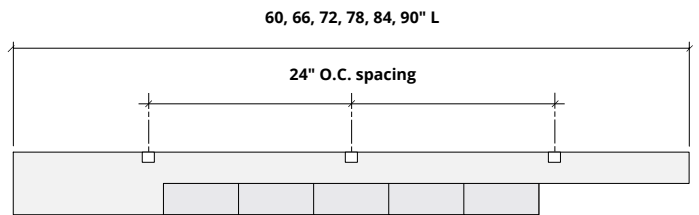
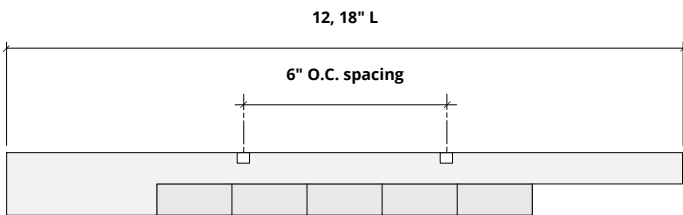

How to Specify

1. Choose Module Size

2. Choose Module Quantity

3. Choose Mounting Method

Determine preferred material thickness, length and height.

1. Choose Module Size

2. Choose Module Quantity

3. Choose Mounting Method

Each module includes 6 baffles installed 8" on center.

Single module

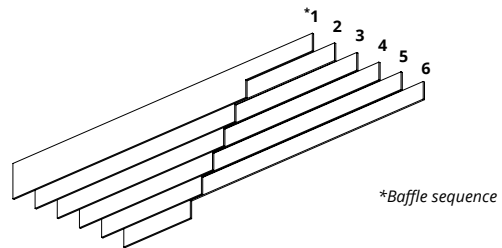
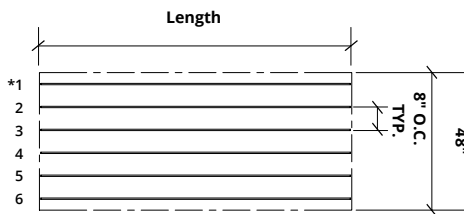

Multiple modules

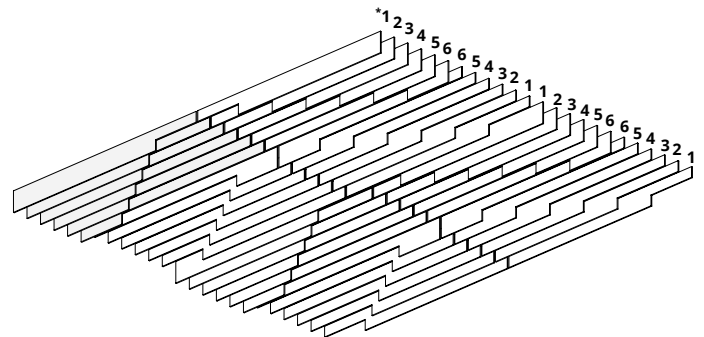
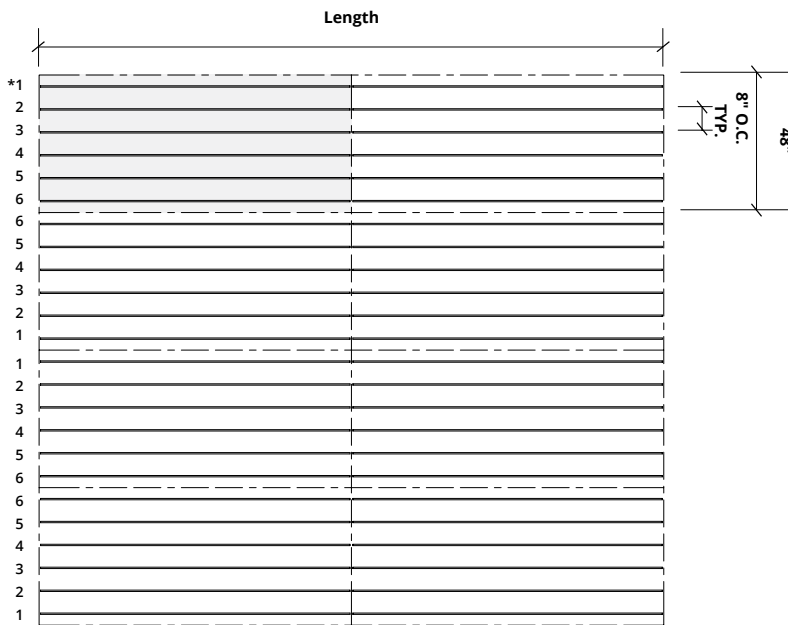

1. Choose Module Size

2. Choose Module Quantity

3. Choose Mounting Method

There are several mounting methods available. Choose one that works best for your project needs and preferred aesthetic.



Mounting Methods

Cable

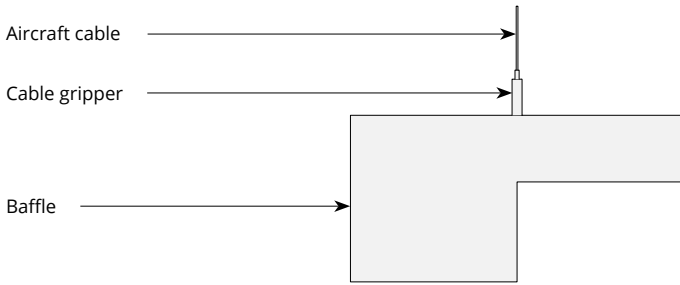

Cable to deck

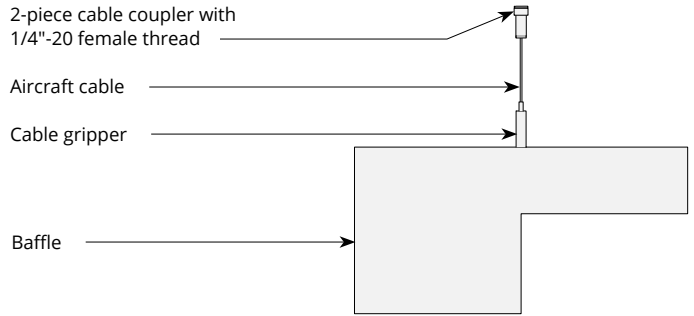

Cable to T-grid

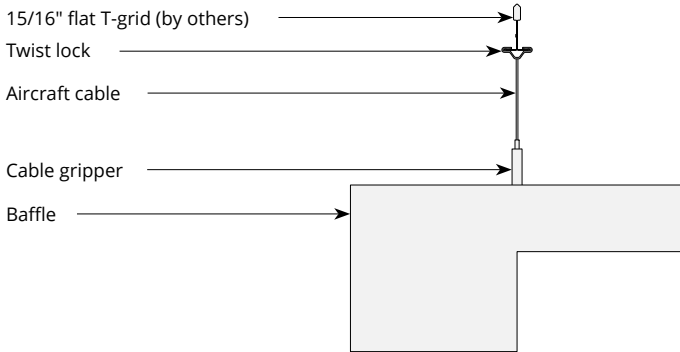

Cable to Unistrut

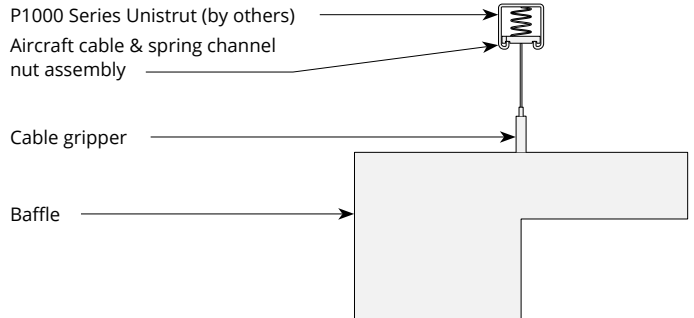

Swivel cable to deck

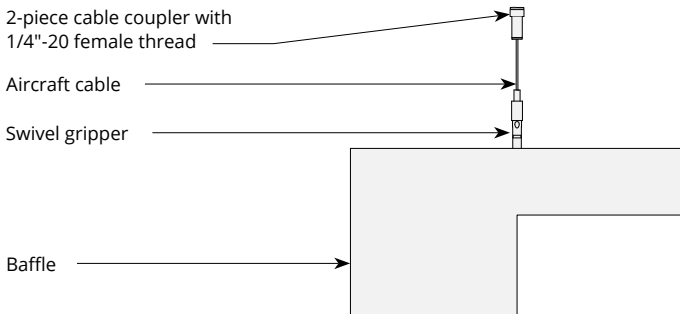

Magnet to T-grid

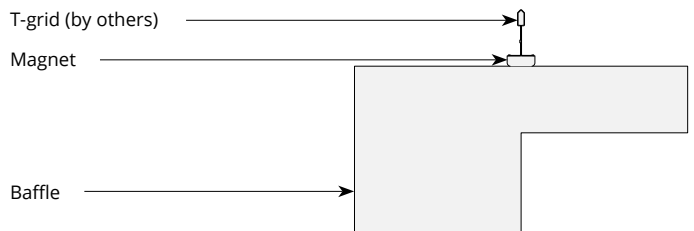

Mounting Methods cont'd.

Threaded rod

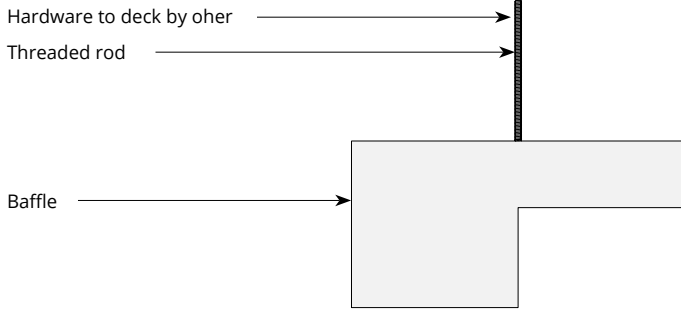

Threaded rod to Unistrut

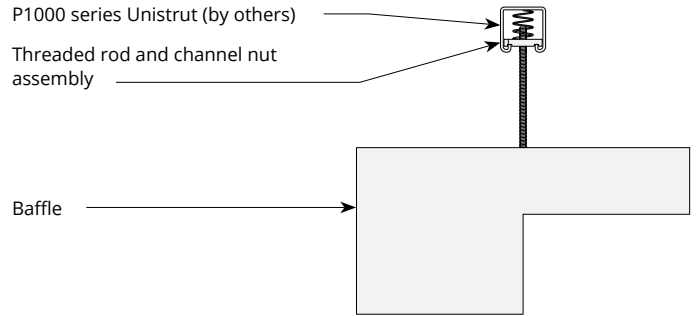

Direct to Unistrut

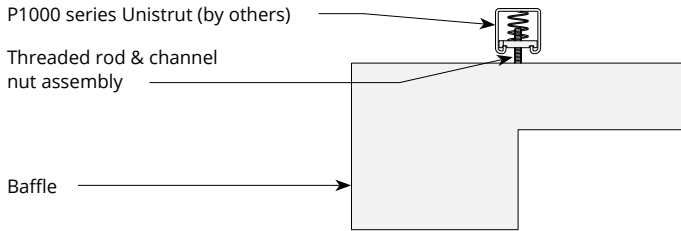

Twist lock to T-grid

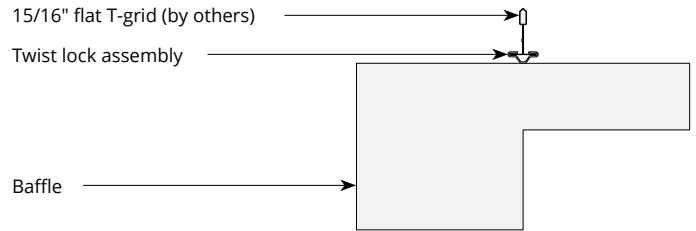

Acoustic Performance

Test Method	ASTM E795-16
Install Method	J-600
Rating Method	ASTM C423-17
Mounting Method	Sample tested 6 baffles 110" L x 12" D, 12mm and 24mm thickness, sample hanging 600mm from floor and 6" O.C. from each other
Test Results	NRC 1.30 SAA 1.32

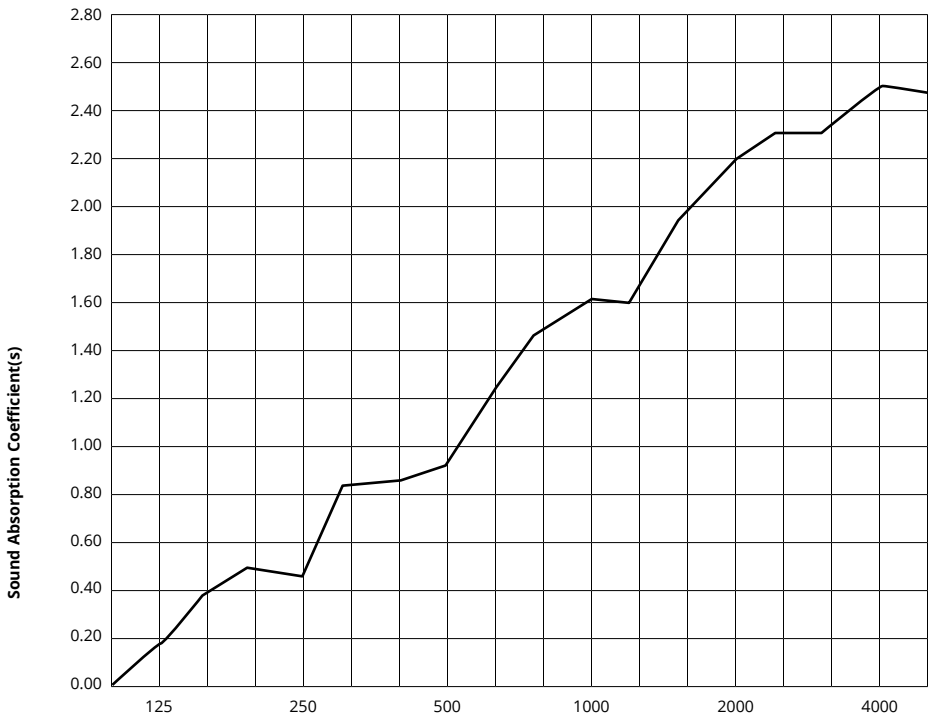

Frequency f (Hz)	125	250	500	1000	2000	4000	NRC
12mm	0.17	0.44	.93	1.62	2.20	2.51	1.30

What is a Noise Reduction Coefficient (NRC)?

You'll find the NRC rating in the specifications of all of our products. This acronym stands for Noise Reduction Coefficient, and is expressed as a single number, a rating that describes the degree to which acoustic products can absorb sound.

You can use NRC values to understand the overall performance of our acoustic wall and ceiling products. The higher the NRC, the better the product is at soaking up the sound.

Performance Indices: Noise Reduction Coefficient (NRC) results represent the absorption coefficients measured at the one third octave bands at 125, 250, 500, 1000, 2000 and 4000 Hz rounded to the nearest 0.05. Acoustic testing has been performed according to the methods mentioned above. Customization of installation of the product could alter the results. Sound Absorption Average (SAA) indicates the absorption coefficient average for the twelve one-third octave bands ranging between 200 and 2500 Hz.