

Canopy

Ceiling Clouds

Naturals Collection

Refresh your space and how people experience it. A suspended canopy of raw wool baffles beautifully dampens sound and creates a more relaxed, sustaining environment. Rectangular panels with two-inch raised edges reflect the scale of today's open spaces, adding volume as well as greater sound-absorbing surface area.

Specifications

Surface	Ceiling
Material	100% wool
Thickness	1/2", 12mm (±10%) 3mm <i>Naturals</i> + 9mm <i>Essentials</i>
Weight	0.49 lb./ft ² (±10%)
Standard Sizes	20" W x 44" L x 2" H 20" W x 96" L x 2" H 44" W x 44" L x 2" H 44" W x 96" L x 2" H



Canopy Ceiling Clouds in Wintergreen

Technical

NRC Rating	Testing is pending
Fire Test	ASTM E84, Class 1 Flame spread index: 7 Smoke developed index: 160
Colorfastness	ISO 105-B02, 4
Certifications	100% Mulesing-free pure wool

Details

Lead Time	3 – 6 weeks
Origin	Manufactured and assembled in the US
Warranty	Product: 10 years*

* Conditions apply

Environmental

Indoor Air Quality	VOC less than/equal to 0.5mg/m ³
Recyclable	100%*
Certifications	Oeko-Tex® Standard 100 Certified Product Class II (100% Wool Design Felt)

* Wool is recyclable through participating partners.



Colorways

NATURALS



Coconut
CO02



Fog
FO01

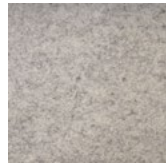

Ash
AS08



Wintergreen
WI06



Grassland
GR07



Zest
ZE04

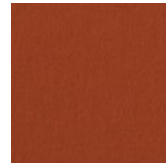

Fox
FO05



Shell
SH10



Fawn
FA03



Cliffside
CL15



Indigo
IN20



Ocean
OC13

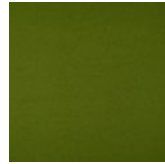

Hedge
HW14

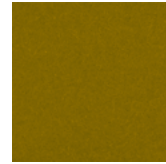

Tapenade
TA11

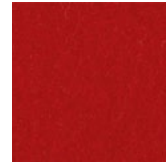

Amaryllis
AM12



Mulberry
MU17



Thicket
TH09

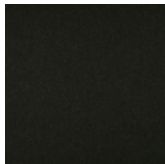

Raven
RA1

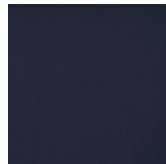

Night Sky
NI19



Balsam
BA21

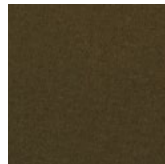

Kelp
KE18

Order samples at acoufelt.com/colorways

Sizes

Standard Sizes	20" W x 44" L x 2" H
	20" W x 96" L x 2" H
	44" W x 44" L x 2" H
	44" W x 96" L x 2" H

Thickness	1/2", 12mm (±10%)
------------------	-------------------

12mm
thickness



Elevation

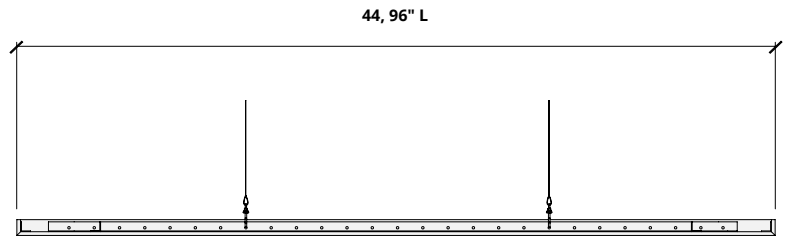

Perspective

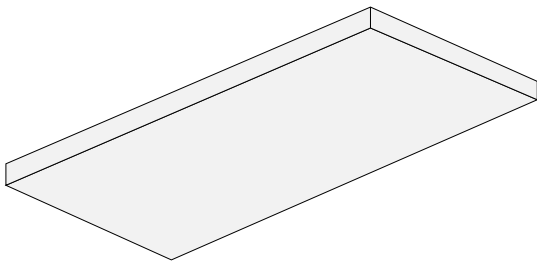

Plan

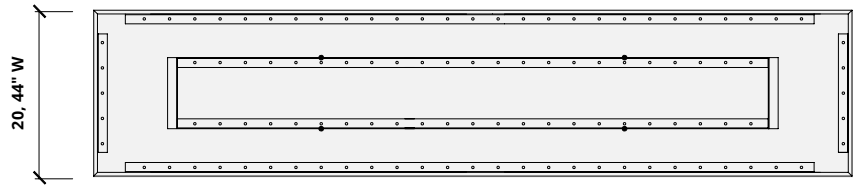

Perspective

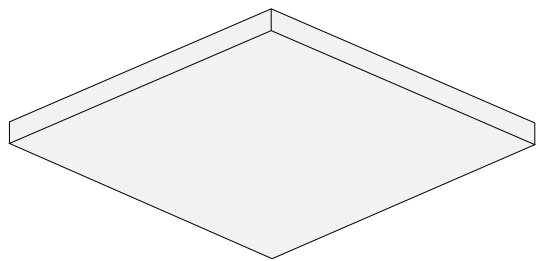

Plan

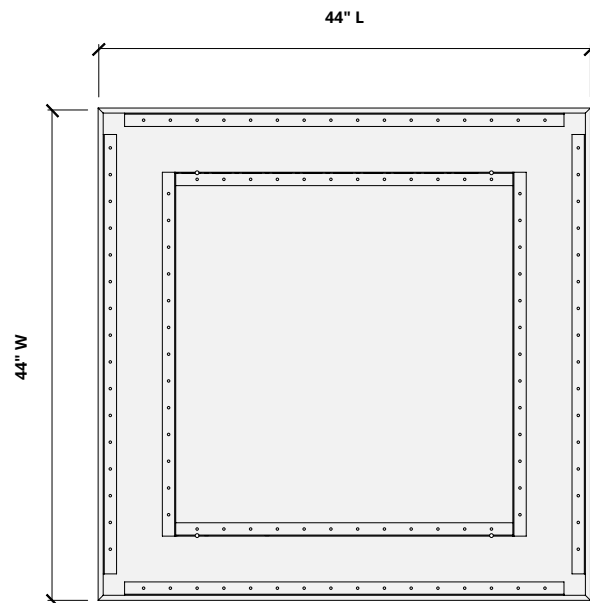

Hardware Spacing

20" W	6.5" on center spacing
44" W	27" on center spacing
44" L	27" on center spacing
96" L	78" on center spacing

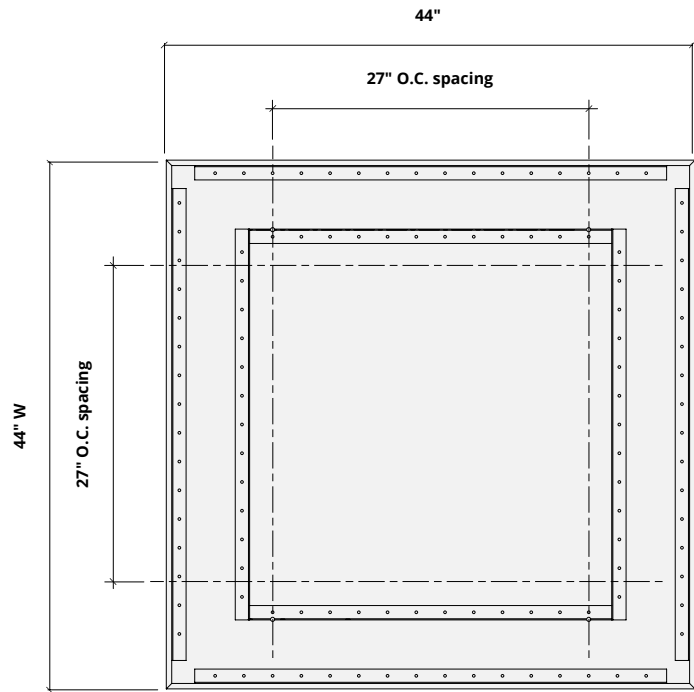
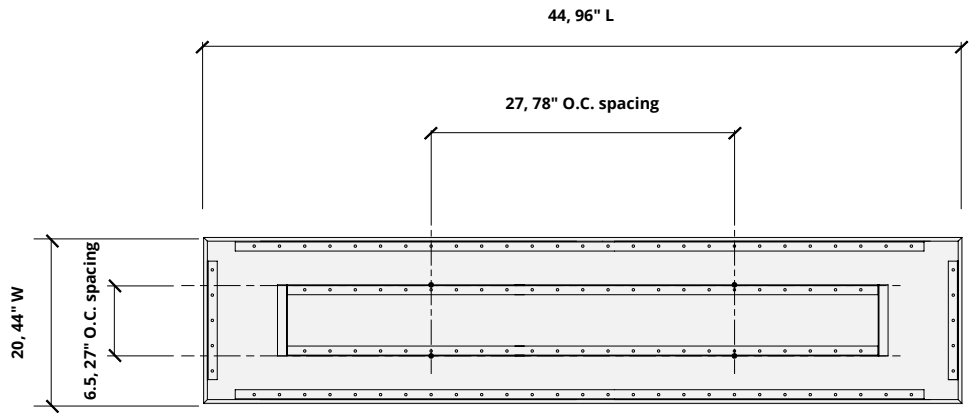

Mounting Methods

Cable

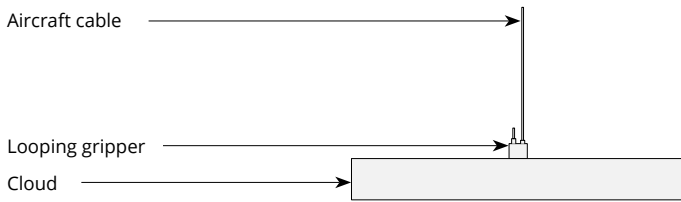

Cable to deck

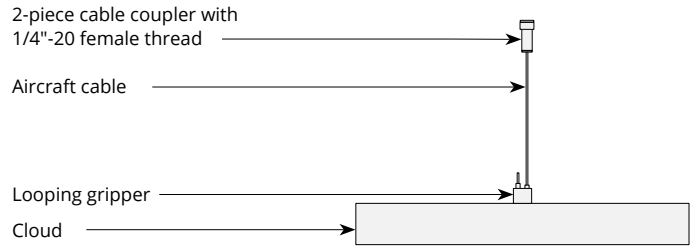

Cable to T-grid

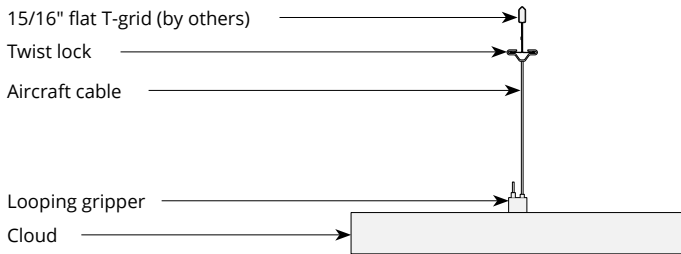

Cable to Unistrut

