



Pixel Wall Panels

Naturals Collection

Punctuate a space with visually appealing color, shadow, and texture. Simple, symmetric graphics are cut into the face of this double-layer, raw wool felt, letting a second color peek through. Pixel makes this durable, renewable, time-honored sound management solution brand new.

Specifications

Surface	Wall
Material	100% wool
Thickness	1/2", 12mm (±10%) 3mm <i>Naturals</i> + 9mm <i>Essentials</i>
Weight	0.49 lb./ft ² (±10%)
Standard Sizes	48" W x 108" H <i>Custom sizes available</i>

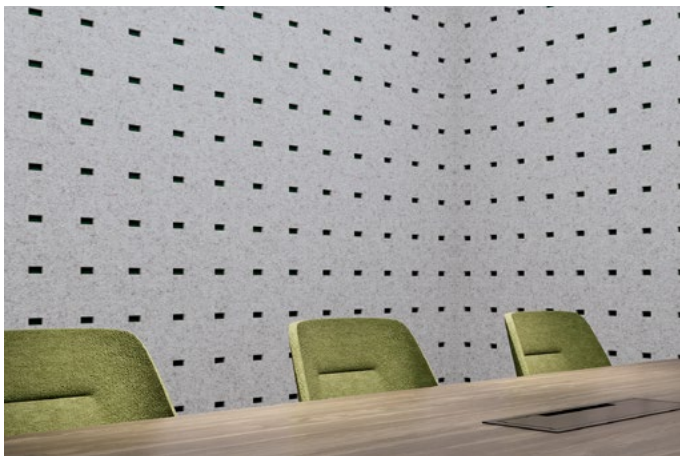

Pixel Wall Panel with Rectangle Pattern in Balsam and Arctic

Technical

NRC Rating	Testing is pending
Fire Test	ASTM E84, Class 1 Flame spread index: 7 Smoke developed index: 160
Colorfastness	ISO 105-B02, 4
Certifications	100% Mulesing-free pure wool

Details

Lead Time	3 – 6 weeks
Origin	Manufactured and assembled in the US
Warranty	Product: 10 years*

* *Conditions apply*

Environmental

Indoor Air Quality	VOC less than/equal to 0.5mg/m ³
Recyclable	100%*
Certifications	Oeko-Tex® Standard 100 Certified Product Class II (100% Wool Design Felt)

* *Wool is recyclable through participating partners.*



Colorways

NATURALS



Coconut
CO02



Fog
FO01

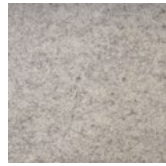

Ash
AS08



Wintergreen
WI06



Grassland
GR07



Zest
ZE04

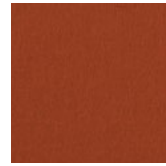

Fox
FO05



Shell
SH10



Fawn
FA03



Cliffside
CL15



Indigo
IN20

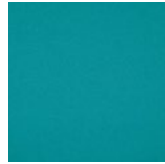

Ocean
OC13

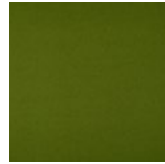

Hedge
HW14

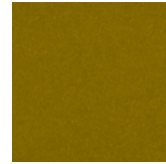

Tapenade
TA11

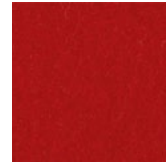

Amaryllis
AM12



Mulberry
MU17



Thicket
TH09

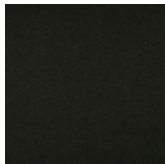

Raven
RA1

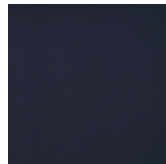

Night Sky
NI19

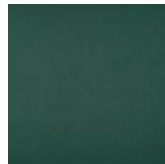

Balsam
BA21

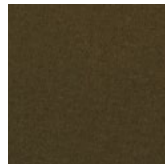

Kelp
KE18

Order samples at acoufelt.com/colorways



Call 800.966.8557 with questions or visit acoufelt.com for more product information, downloads, and colorways.

Colorways

ESSENTIALS

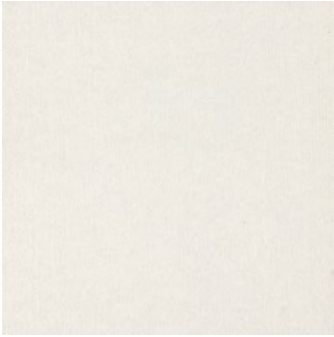

Talc
TA08



Limestone
LI07



Silt
SI06

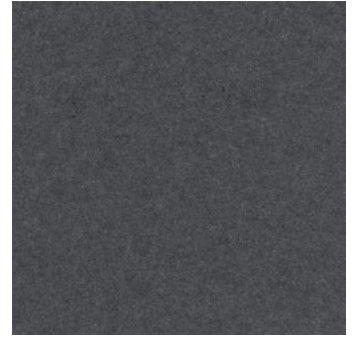

Shale
SH03



Pumice
PU05



Gypsum
GY04



Jade
JA02



Basalt
BA01

Order samples at acoufelt.com/colorways



Call **800.966.8557** with questions or visit acoufelt.com for more product information, downloads, and colorways.

Sizes

Standard Sizes	48" W x 108" H <i>Custom sizes available</i>
Thickness	1/2", 12mm (±10%) <i>3mm Naturals + 9mm Essentials</i>

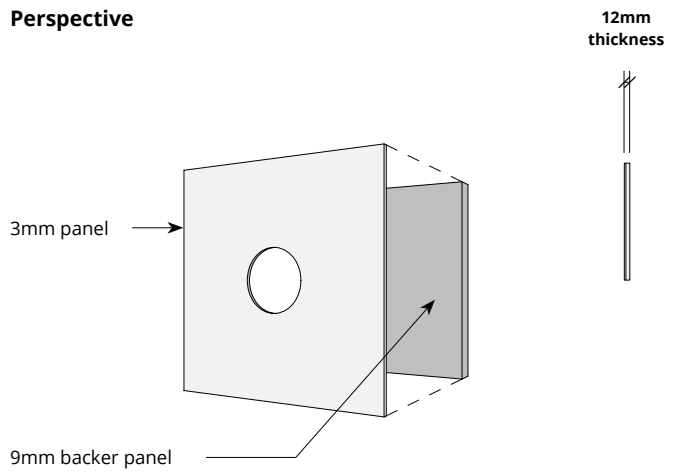
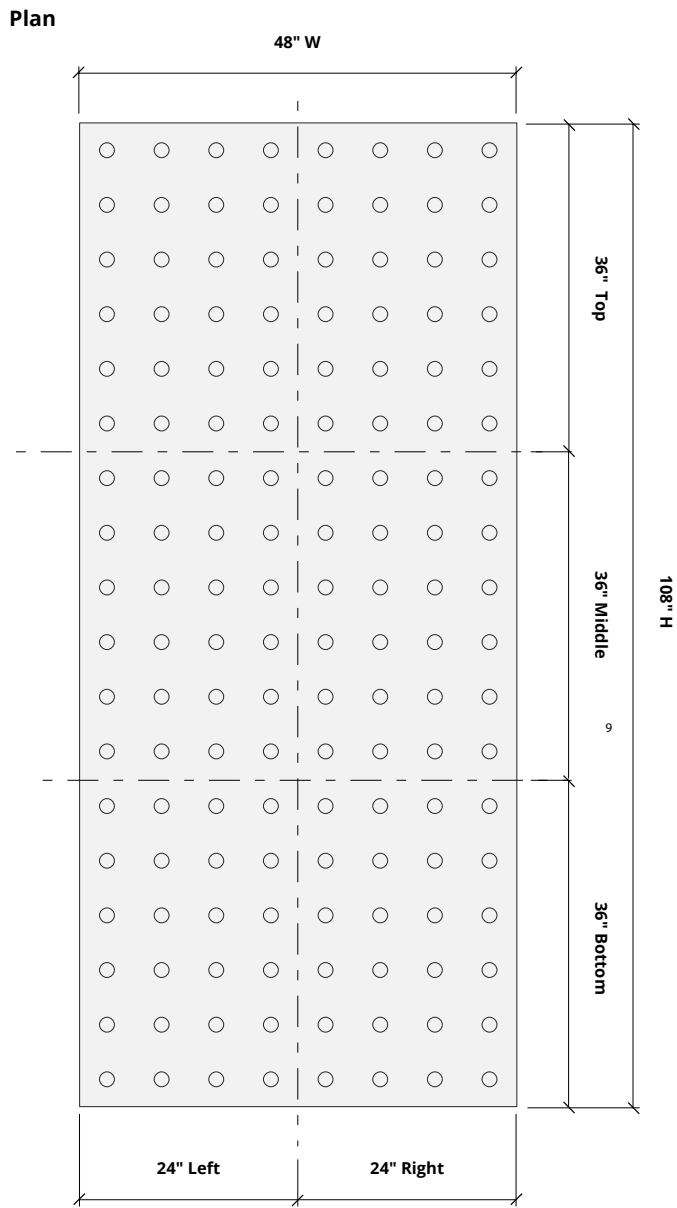

* Product available as full panels or as sections of a panel as filler pieces.
Choose any of the standard height or segments (i.e. bottom right, middle left, etc) to fill the space as needed.

How to Specify

1. Choose Panel Pattern

2. Choose Colorways

Select desired panel pattern.

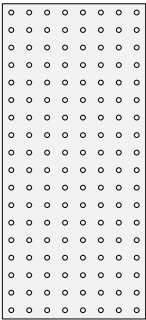

CIRCLE

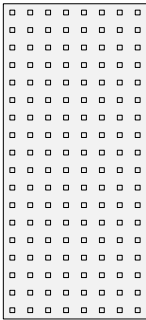

SQUARE

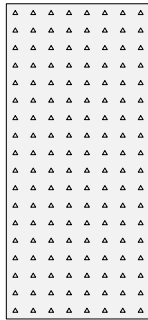

TRIANGLE

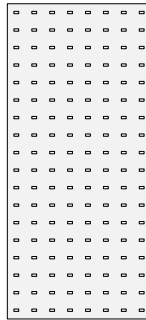

RECTANGLE

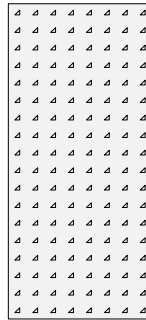

RIGHT TRIANGLE

1. Choose Panel Pattern

2. Choose Colorways

Select two colors: one for the face panel (Naturals) and one for the backer panel (Essentials) to create a Pixel that is uniquely yours. See colorways on page 3 and 4.

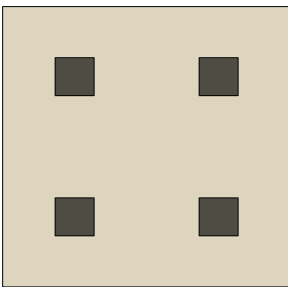

Square in Fog and Shale



Mounting Methods

Adhesive backing

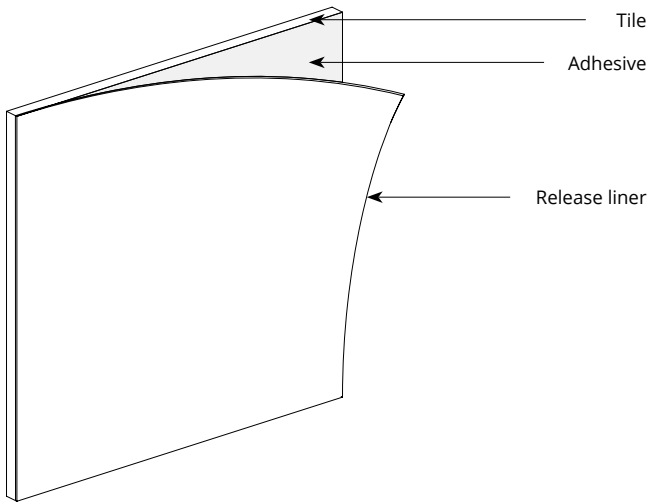

Construction adhesive

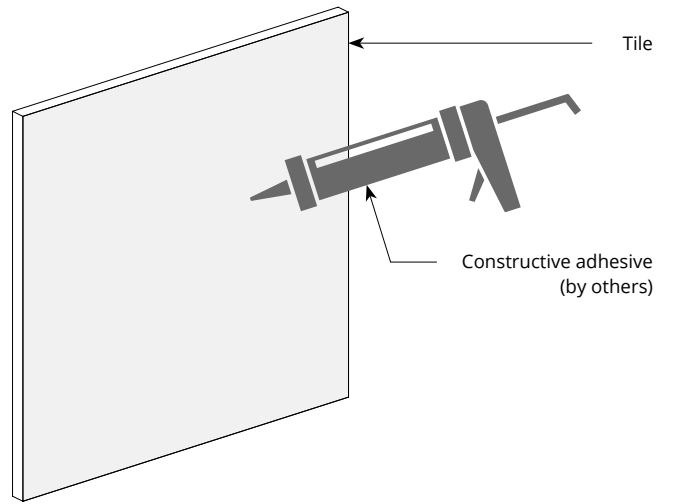

Z-clip wall mount

