

Fracture Two-Tone Wall Panels

Naturals Collection

Wear your brand – and your values – on your walls. Choose renewable, eco-friendly all wool felt. Our two-layer process cuts your choice of proprietary Acoufelt patterns into the top layer of wool, revealing a second color beneath. It's a sustainable and modern look that makes your brand look great.

Specifications

Surface	Wall
Material	100% wool
Thickness	1/2", 12mm (±10%) 3mm Naturals + 9mm Essentials
Weight	0.49 lb./ft ² (±10%)
Standard Sizes	48" W x 108" H Custom sizes available



Fracture Two-Tone Wall Panel with Vapor Pattern in Fox and Ash

Technical

NRC Rating	Testing is pending
Fire Test	ASTM E84, Class 1 Flame spread index: 7 Smoke developed index: 160
Colorfastness	ISO 105-B02, 4
Certifications	100% Mulesing-free pure wool

Details

Lead Time	3 – 6 weeks
Origin	Manufactured and assembled in the US
Warranty	Product: 10 years*

* Conditions apply

Environmental

Indoor Air Quality	VOC less than/equal to 0.5mg/m ³
Recyclable	100%*
Certifications	Oeko-Tex® Standard 100 Certified Product Class II (100% Wool Design Felt)

* Wool is recyclable through participating partners.



Colorways

NATURALS



Coconut
CO02



Fog
FO01

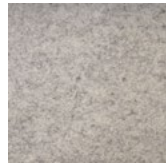

Ash
AS08



Wintergreen
WI06



Grassland
GR07



Zest
ZE04

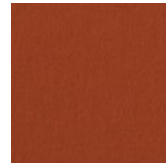

Fox
FO05



Shell
SH10



Fawn
FA03



Cliffside
CL15



Indigo
IN20



Ocean
OC13

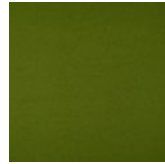

Hedge
HW14

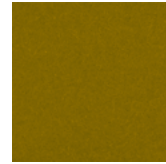

Tapenade
TA11

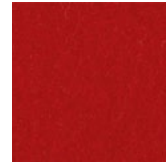

Amaryllis
AM12



Mulberry
MU17



Thicket
TH09

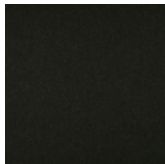

Raven
RA1

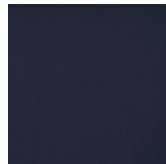

Night Sky
NI19



Balsam
BA21

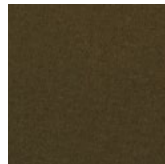

Kelp
KE18

Order samples at acoufelt.com/colorways



Call **800.966.8557** with questions or visit acoufelt.com for more product information, downloads, and colorways.

ESSENTIALS

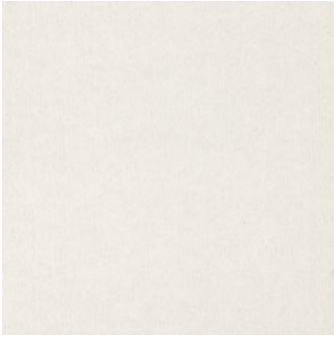

Talc
TA08



Limestone
LI07



Silt
SI06

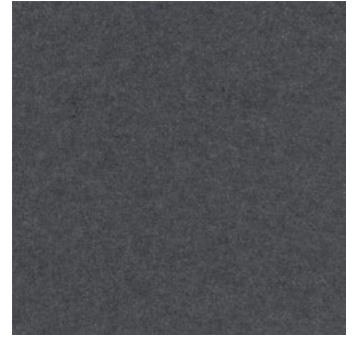

Shale
SH03



Pumice
PU05



Gypsum
GY04



Jade
JA02



Basalt
BA01

Order samples at acoufelt.com/colorways



Call **800.966.8557** with questions or visit acoufelt.com for more product information, downloads, and colorways.

Sizes

Standard Sizes	48" W x 108" H <i>Custom sizes available</i>
Thickness	1/2", 12mm (±10%) <i>3mm Naturals + 9mm Essentials</i>

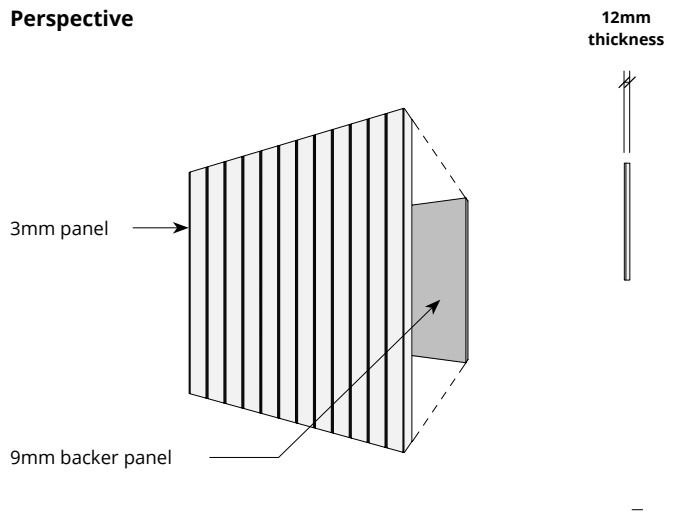
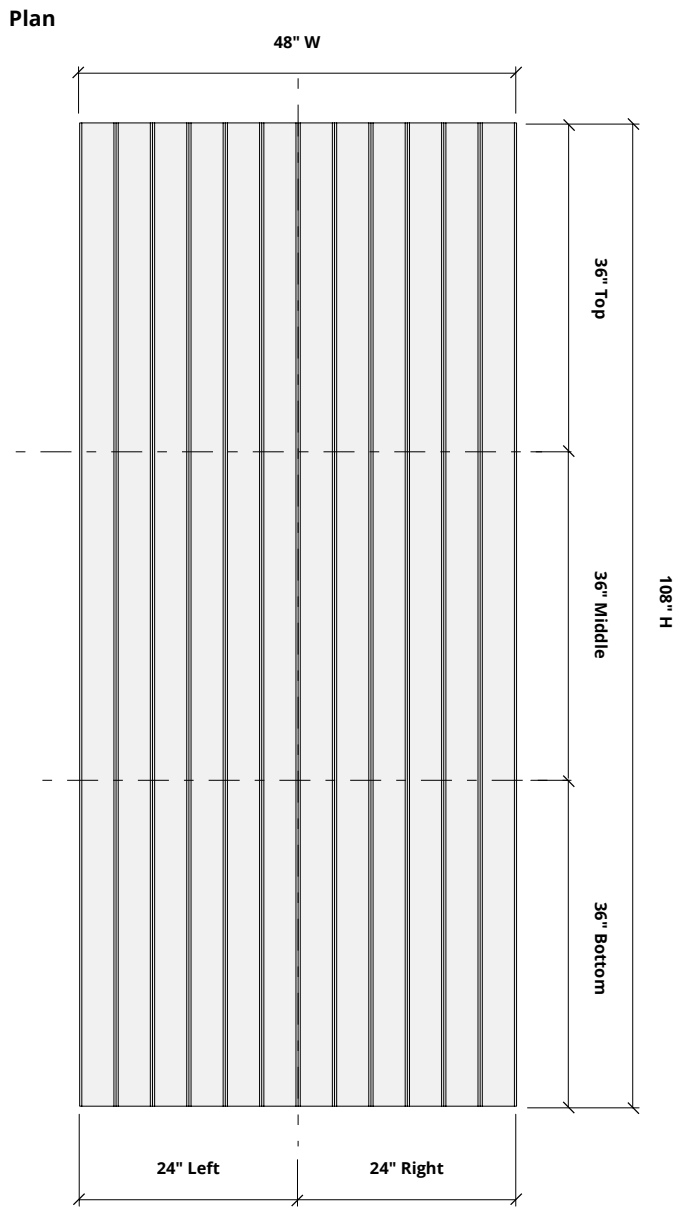

* Product available as full panels or as sections of a panel as filler pieces.
Choose any of the standard height or segments (i.e. bottom right, middle left, etc) to fill the space as needed.

How to Specify

1. Choose Panel Pattern

2. Choose Colorways

Select desired panel pattern. See recommended layouts for larger designs.

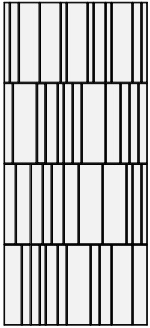

BARCODE

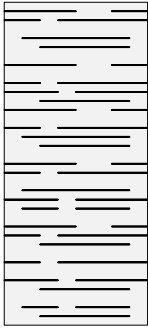

DASH

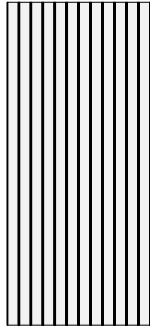

FINELINE

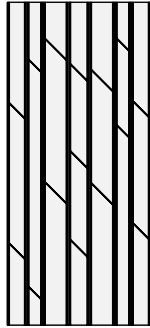

OPTICS

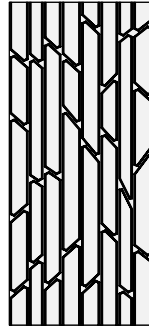

SHARD

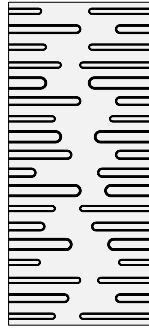

VAPOR

1. Choose Panel Pattern

2. Choose Colorways

Select two colors: one for the face panel (Naturals) and one for the backer panel (Essentials) to create a Fracture Two-Tone that is uniquely yours. See colorways on page 3 and 4.

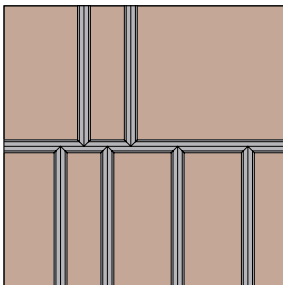

Barcode in Shell and Pumice



Recommended Layouts

Barcode

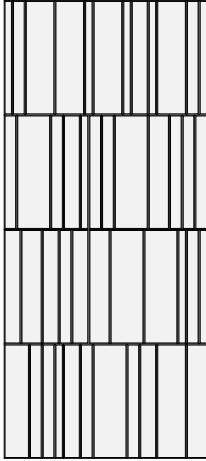

Layout 1

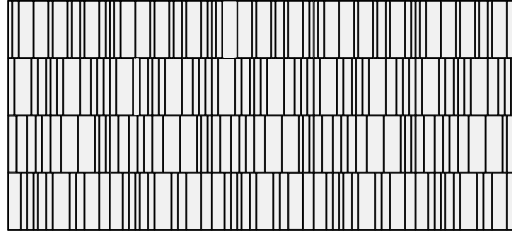

Layout 2

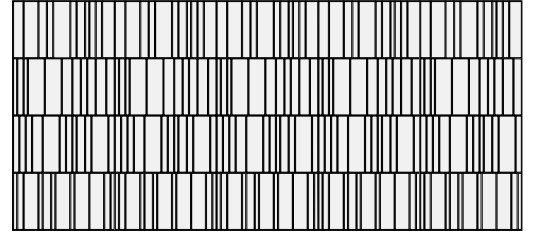

Layout 3

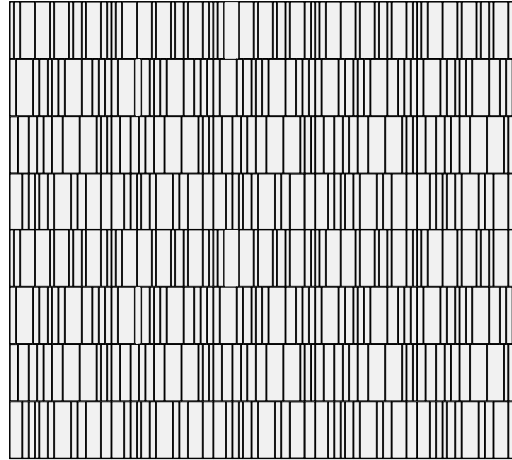

Layout 4

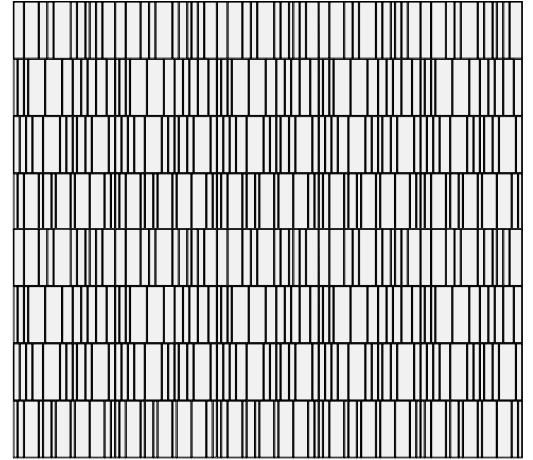

Perspective

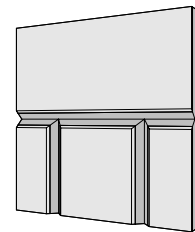

Recommended Layouts

Dash

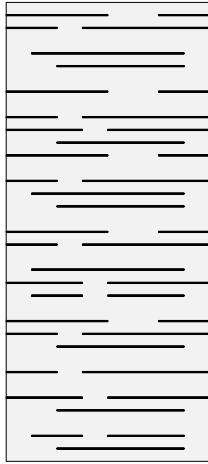

Layout 1

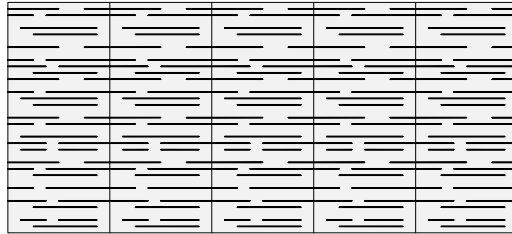

Layout 2

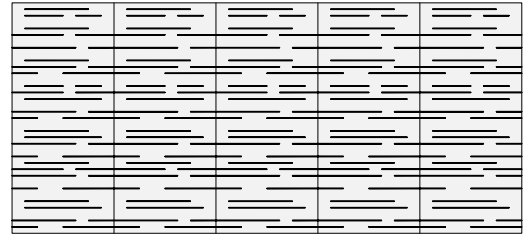

Layout 3

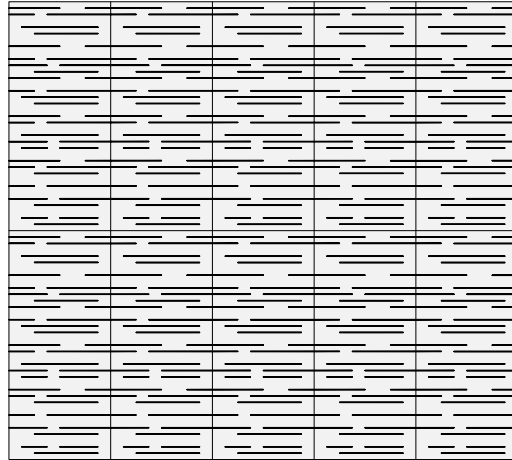

Layout 4

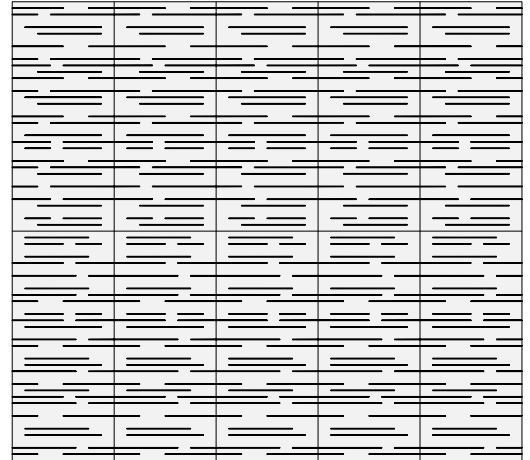

Perspective

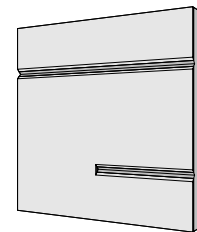

Recommended Layouts

Fineline

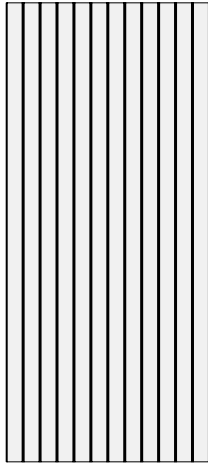

Layout 1

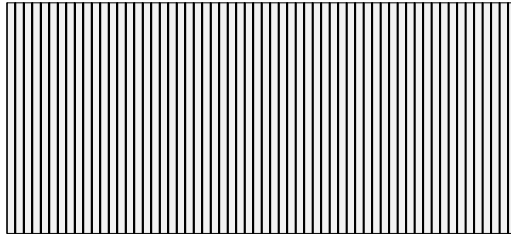

Layout 2

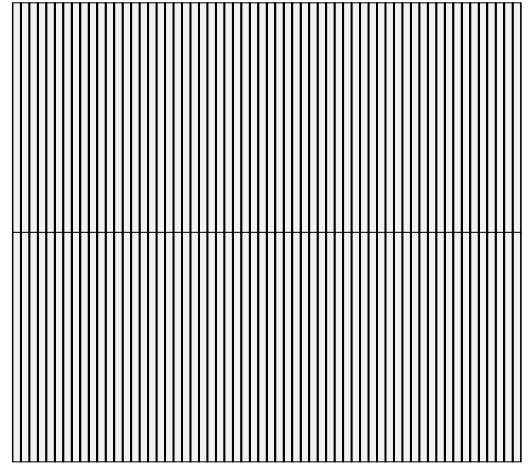

Perspective

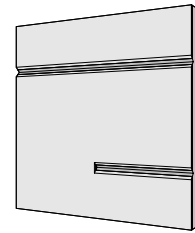

Recommended Layouts

Optics

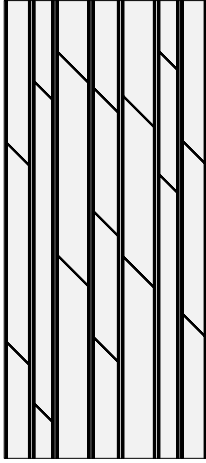

Layout 1

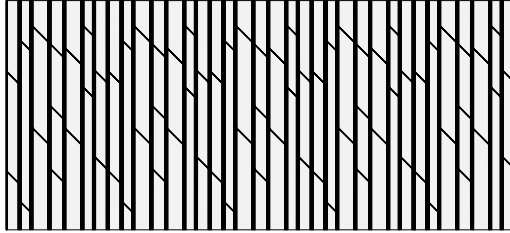

Layout 2

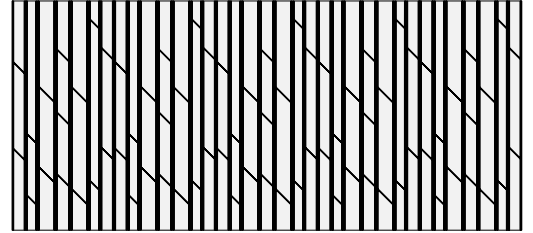

Layout 3

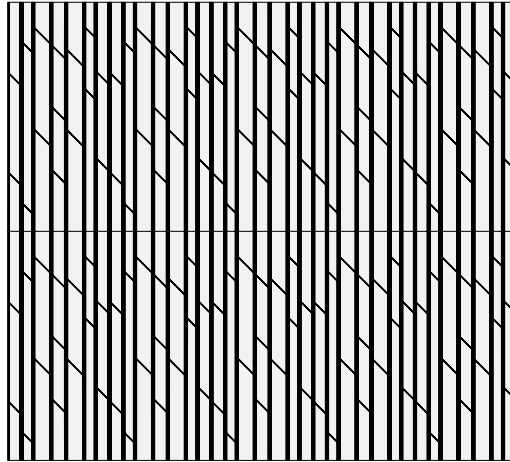

Layout 4

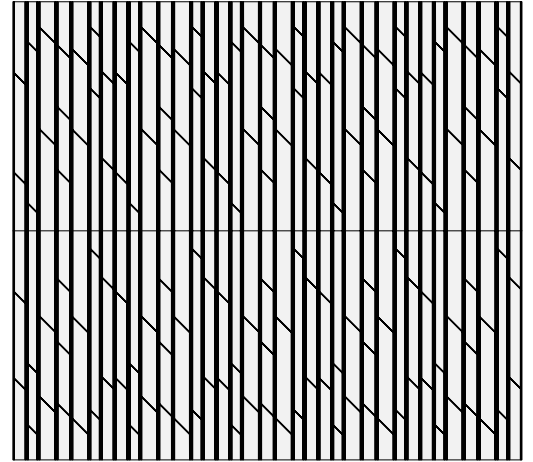

Perspective

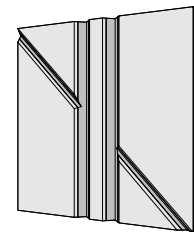

Recommended Layouts

Shard

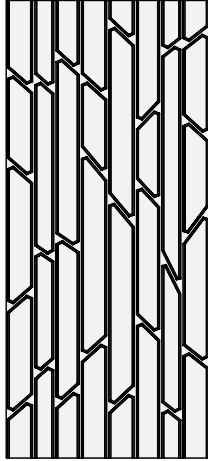

Layout 1

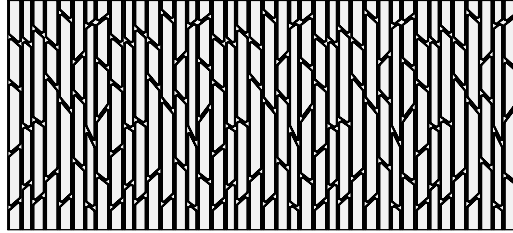

Layout 2

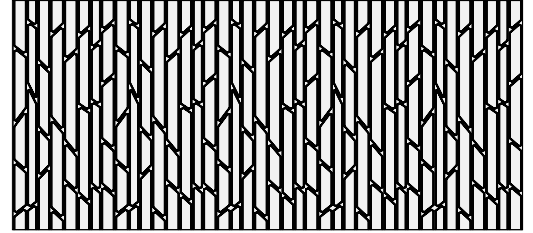

Layout 3

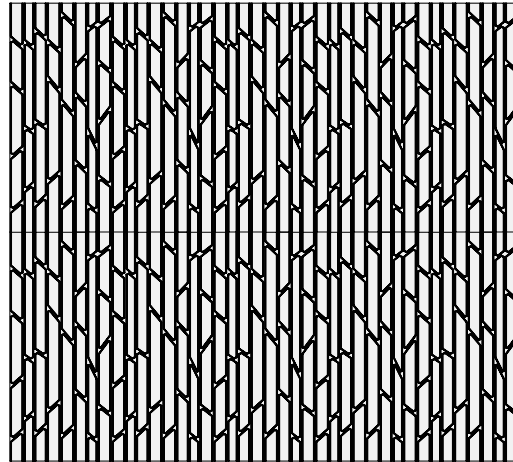

Layout 4

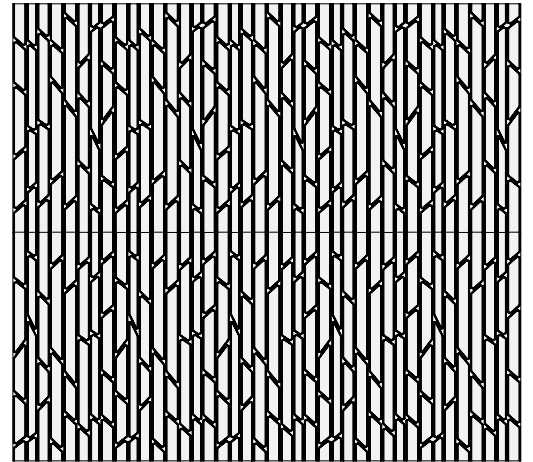

Perspective

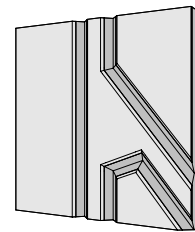

Recommended Layouts

Vapor

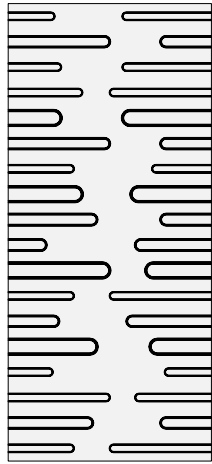

Layout 1

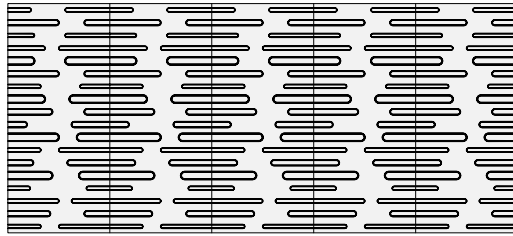

Layout 2

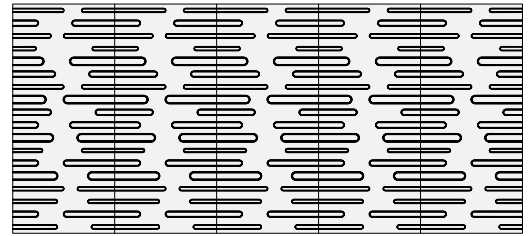

Layout 3

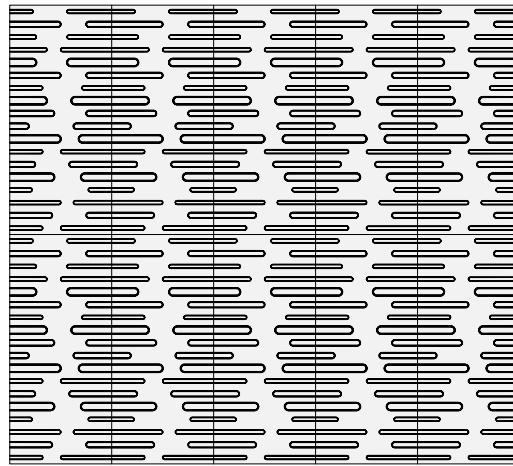

Layout 4

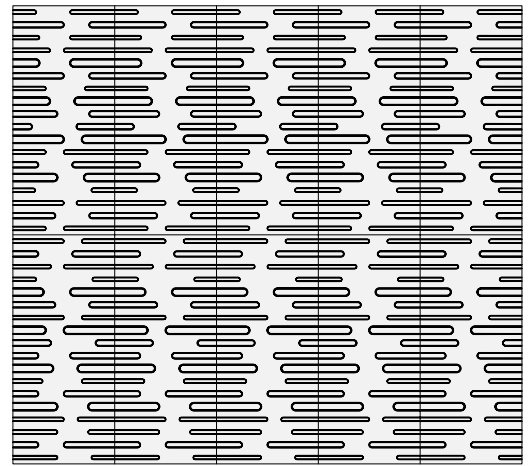

Perspective

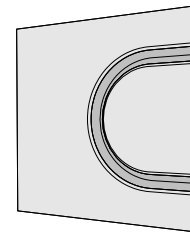

Mounting Methods

Adhesive backing

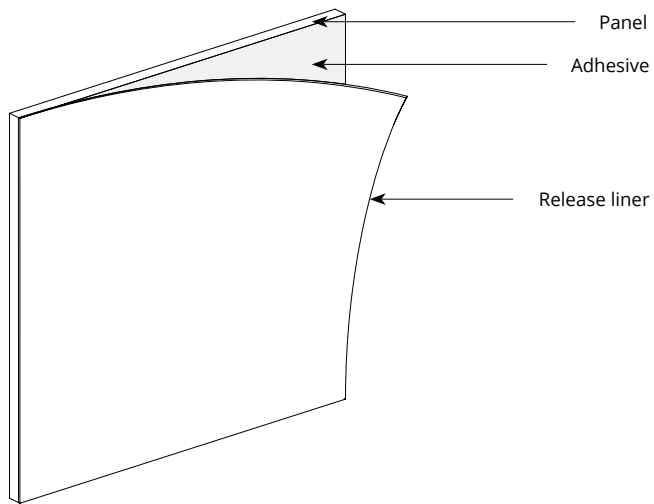

Construction adhesive

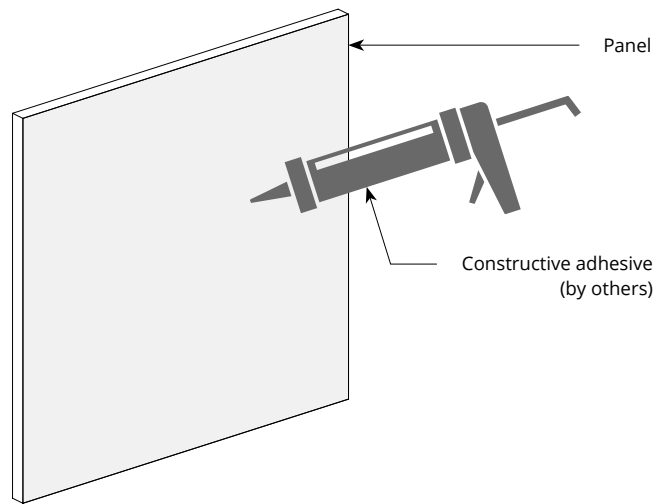

Z-clip wall mount

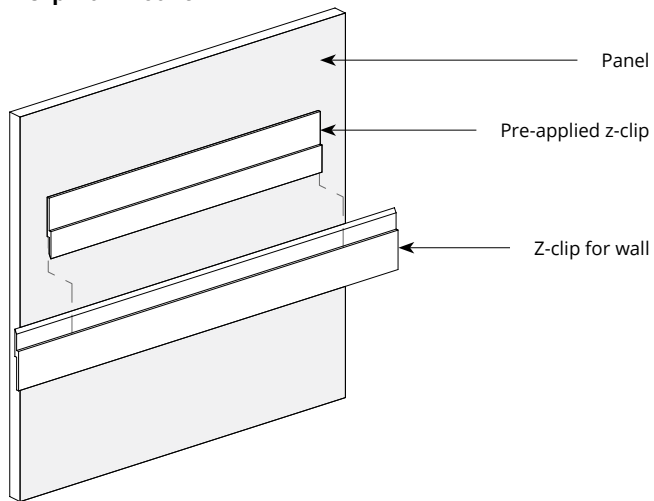

* For wall mount applications only.