



Reveal Ceiling Baffles

Premier Collection

Reveal acoustic baffles utilize a double layer of sound-absorbing materials to control unwanted noise in a variety of situations. A two-tone effect on one side adds color dimension while the opposite viewpoint presents as standard linear baffles.

Specifications

Surface	Ceiling
Material	Filasorb™ polyester felt
Thickness	1", 24mm (±10%)
Weight	0.98 lb./ft ² (±10%)
Standard Sizes	Heights: 4" up to 24" (2" increments) Lengths: Range from 12" up to 110" <i>See page 4 for more details. Custom sizes available</i>



Reveal Ceiling Baffle in Azure and Slate

Technical

NRC Rating	0.60
Fire Test	ASTM E84, Class A Flame spread index: 15 Smoke developed index: 200
Colorfastness	ISO 105-B02, 6-7

Details

Lead Time	3 – 6 weeks
Origin	Manufactured and assembled in the US
Warranty	Product: 20 years* Colorfastness: 20 years*

* Conditions apply

Environmental

Recycled Content	Minimum 60%
Energy	Generated using 40% solar energy
Indoor Air Quality	VOC less than/equal to 0.5mg/m3
Recyclable	100%*
Certifications	Environmental Product Declaration Declare Certification - LBC Red List Free (third-party verified) SCS Global Indoor Advantage Gold

* PET is recyclable through participating partners.



Colorways

PREMIER

							
White WH12	Almond AL55	Pistachio PI25	Celery CE65	Metal ME03	Flamingo FL61	Quartz QU67	Turmeric TU60
							
Platinum PL04	Pearl PE21	Eucalyptus EU71	Sencha SE58	Periwinkle PE23	Amethyst AM69	Valentine VA70	Wheat WH68
							
Grey GR02	Ivory IV11	Wasabi WA29	Sea Salt SE57	Marine MA15	Lilac LI13	Peach PE19	Popcorn PO26
							
Slate SL27	Umber UM54	Thistle TH28	Peacock PE20	Iris IR10	Berry BE06	Peppercorn PE22	Carrot CA08
							
Charcoal CH01	Walnut WA56	Oregano OR18	Azure AZ05	Granite GR62	Flint FL64	Shiraz SH63	Currant CU59
							
Piano Black PI24	Midnight MI16	Kale KA12	Denim DE09				

Order samples at acoufelt.com/colorways



Call 800.966.8557 with questions or visit acoufelt.com for more product information, downloads, and colorways.

Sizes

Standard Heights 4" up to 24" (2" increments)
Custom sizes available

Thickness 1", 24mm ($\pm 10\%$)

Standard Lengths 12, 18, 24, 30, 36, 42, 48, 54, 60, 66, 72, 78, 84, 90, 96, 102, 108, 110" L
Custom sizes available

Height
4"
6"
8"
10"
12"
14"
16"
18"
20"
22"
24"

Reveal 1 (RE1)

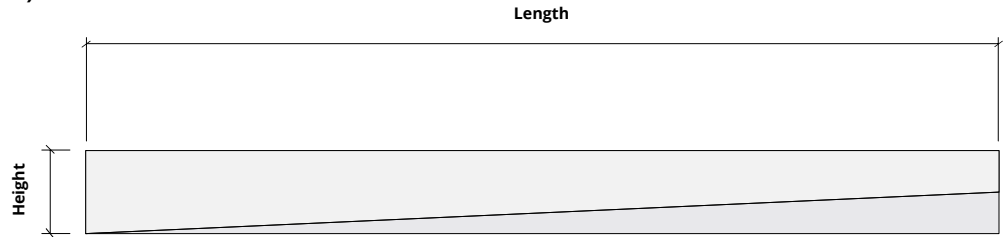

Reveal 2 (RE2)

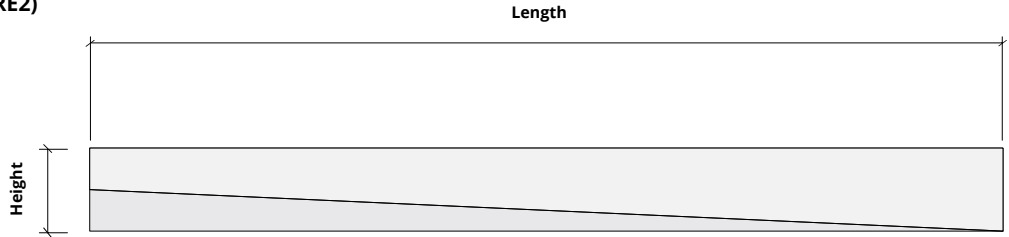

24mm thickness

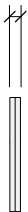

Hardware Spacing

12, 18" L	6" on center spacing
24, 30" L	12" on center spacing
36, 42, 48, 54" L	24" on center spacing
60, 66, 72, 78, 84, 90" L	24" on center spacing
96, 102, 108, 110" L	30" on center spacing

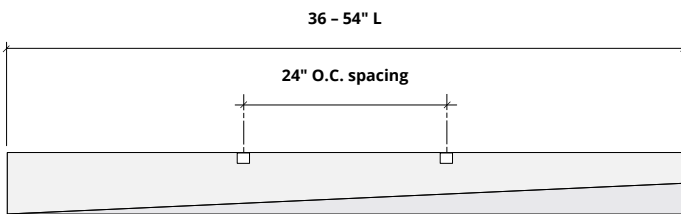
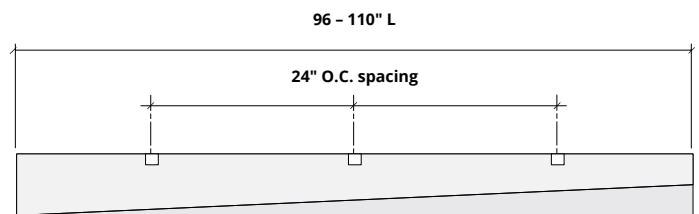
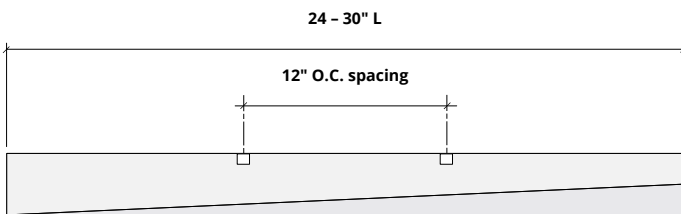
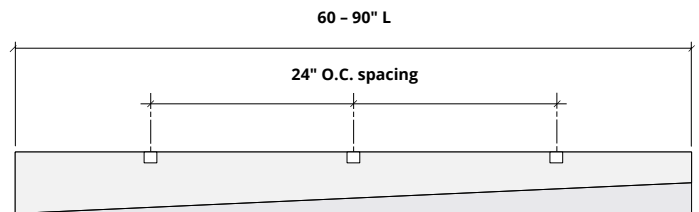
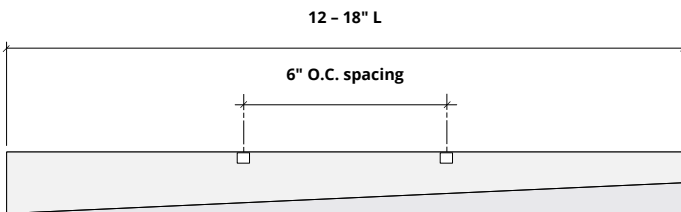

Recommended Layouts

Layout 1 (100% RE1)

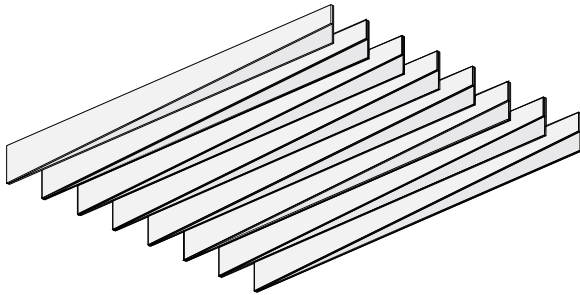

Layout 2 (100% RE2)

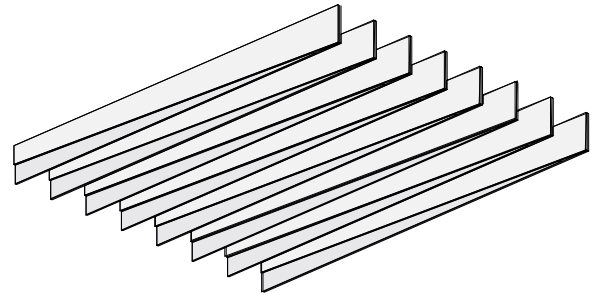

Layout 3 (50% RE1 & 50% RE2)

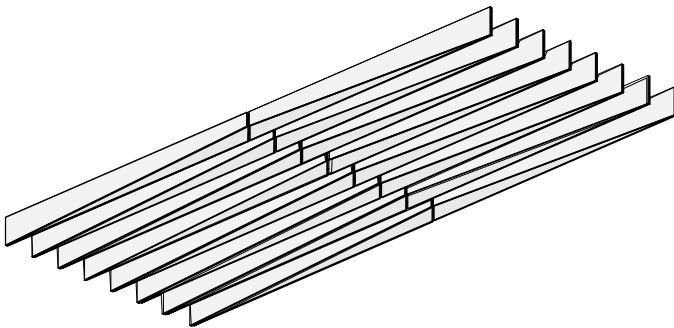

Layout 4 (50% RE1 & 50% RE2)

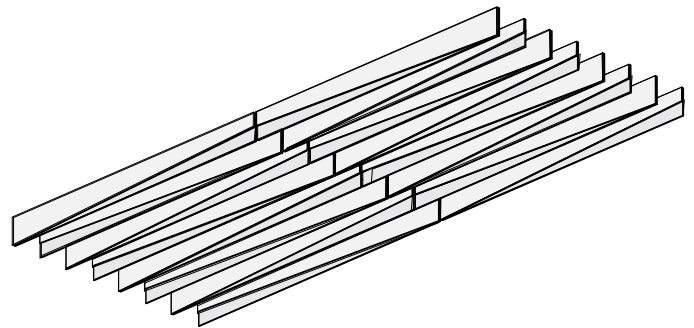

Mounting Methods

Cable

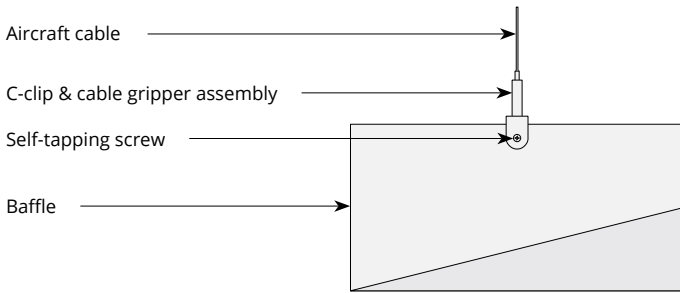

Cable to deck

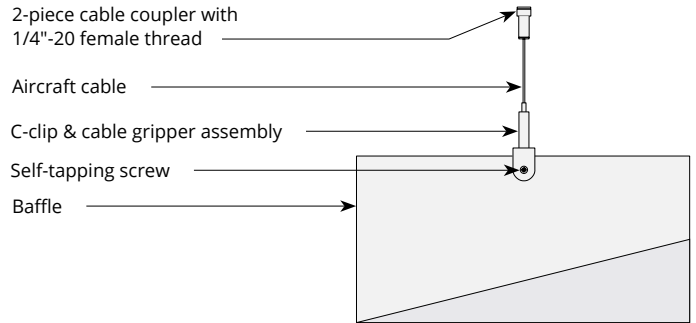

Cable to T-grid

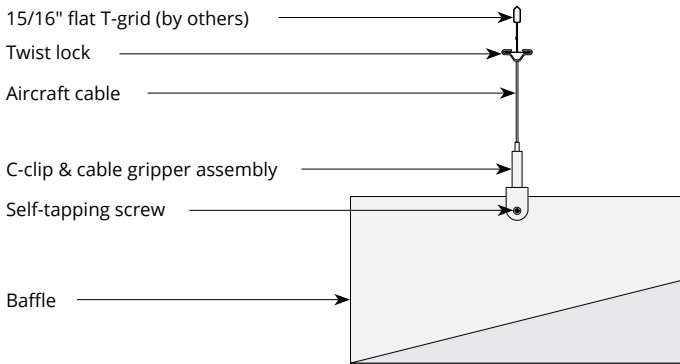

Cable to Unistrut

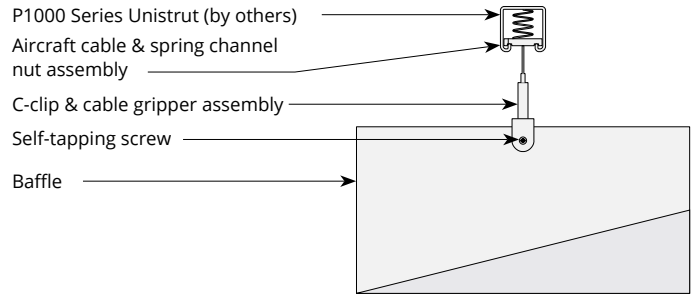

Swivel cable to deck

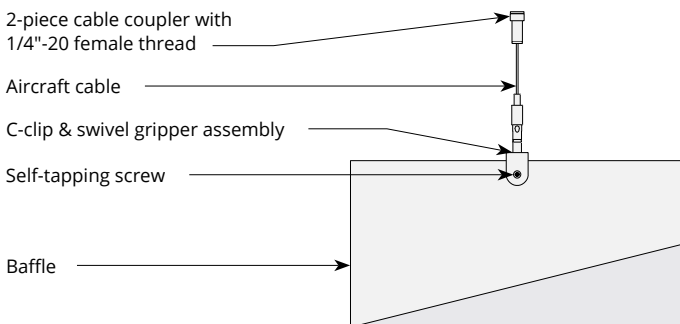

Magnet to T-grid

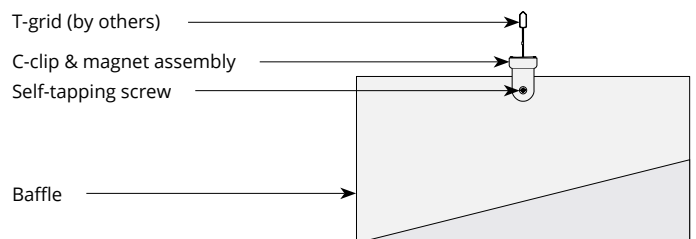

Mounting Methods cont'd.

Threaded rod

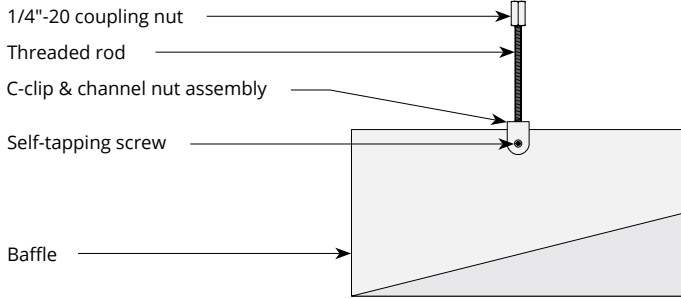

Threaded rod to Unistrut

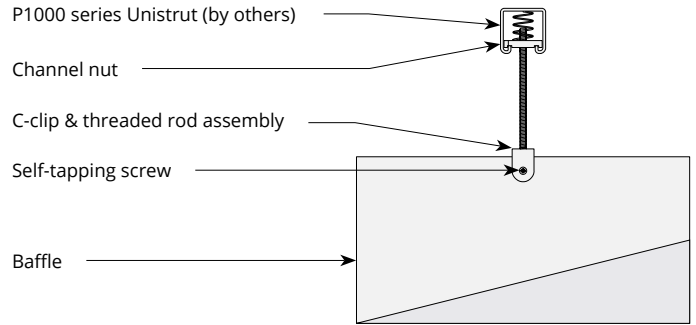

Direct to Unistrut

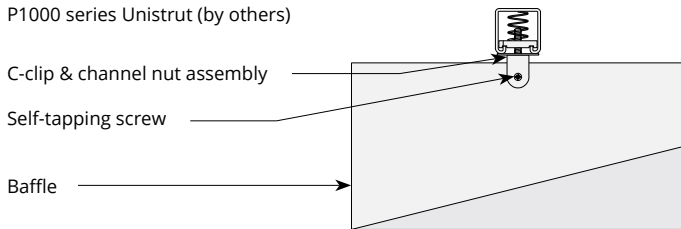

Twist lock to T-grid

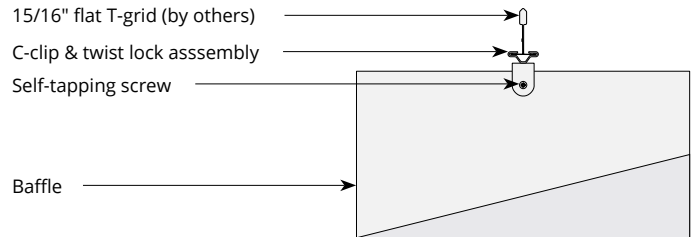

Acoustic Performance

Test Method	ASTM C432-17
Rating Method	ISO 11654-2002
Test Results	NRC 0.60 SAA 0.55

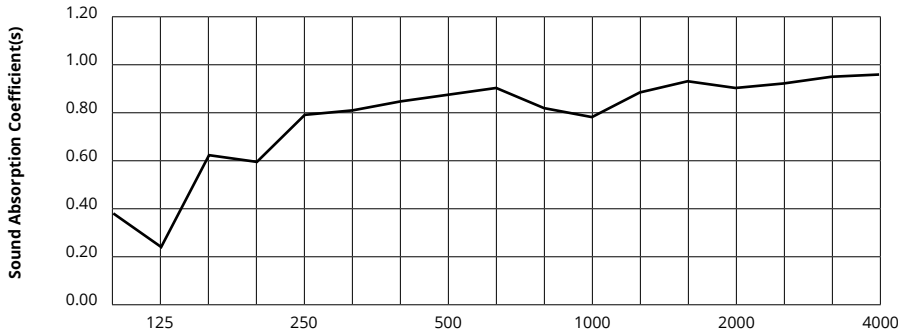

Frequency f (Hz)	125	250	500	1000	2000	4000	NRC
24mm	0.02	0.57	0.41	0.58	0.87	0.85	0.60

What is a Noise Reduction Coefficient (NRC)?

You'll find the NRC rating in the specifications of all of our products. This acronym stands for Noise Reduction Coefficient, and is expressed as a single number, a rating that describes the degree to which acoustic products can absorb sound.

You can use NRC values to understand the overall performance of our acoustic wall and ceiling products. The higher the NRC, the better the product is at soaking up the sound.

Performance Indices: Noise Reduction Coefficient (NRC) results represent the absorption coefficients measured at the one third octave bands at 125, 250, 500, 1000, 2000 and 4000 Hz rounded to the nearest 0.05. Acoustic testing has been performed according to the methods mentioned above. Customization of installation of the product could alter the results. Sound Absorption Average (SAA) indicates the absorption coefficient average for the twelve one-third octave bands ranging between 200 and 2500 Hz.