



## WoodBeQuiet Slat Wall Panels

Woodgrain Collection

WoodBeQuiet Slat walls are an acoustic panel carved with equally spaced vertical v-cuts, and printed with our high-resolution WoodBeQuiet™ woodgrains, creating a finish that imitates that of real timber slats.

## Specifications

<b>Surface</b>	Wall
<b>Material</b>	Filasorb™ polyester felt
<b>Thickness</b>	1/2", 12mm (±10%) 1", 24mm (±10%)
<b>Weight</b>	12mm, 0.49 lb./ft <sup>2</sup> (±10%) 24mm, 0.98 lb./ft <sup>2</sup> (±10%)
<b>Standard Sizes</b>	48" W x 110" H <i>Custom sizes available</i>



WoodBeQuiet Slats 6" W Wall Panel in Boardwalk with Deep Brown V-cut

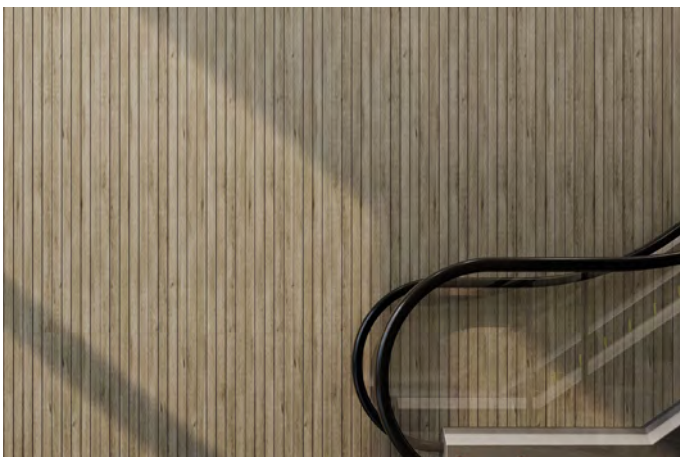

WoodBeQuiet Slats 2" W Wall Panel Slats in Loft with Dark Taupe

## Technical

<b>NRC Rating</b>	12mm, 0.45 24mm, 0.60
<b>Fire Test</b>	ASTM E84, Class A Flame spread index: 15 Smoke developed index: 200
<b>Colorfastness</b>	ISO 105-B02, 6-7

## Details

<b>Lead Time</b>	3 – 6 weeks
<b>Origin</b>	Manufactured and assembled in the US
<b>Warranty</b>	Product: 20 years* Colorfastness: 20 years*

\* Conditions apply

## Environmental

<b>Recycled Content</b>	Minimum 60%
<b>Energy</b>	Generated using 40% solar energy
<b>Indoor Air Quality</b>	VOC less than/equal to 0.5mg/m3
<b>Recyclable</b>	100%*
<b>Certifications</b>	Declare Certification - LBC Red List Free (third-party verified) SCS Global Indoor Advantage Gold

\* PET is recyclable through participating partners.



# Sizes

<b>Standard Sizes</b>	48" W x 110" H <i>Custom sizes available</i>
<b>V-cut Spacing</b>	2, 4, 6, 8" on center

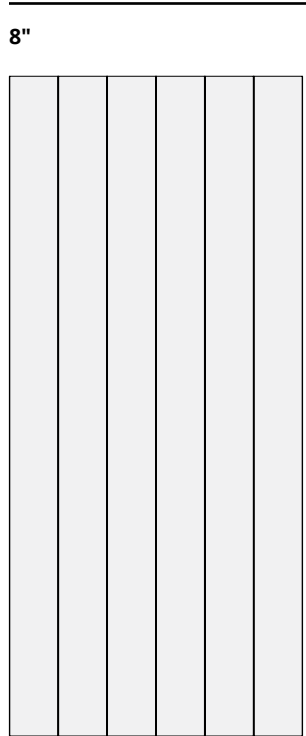
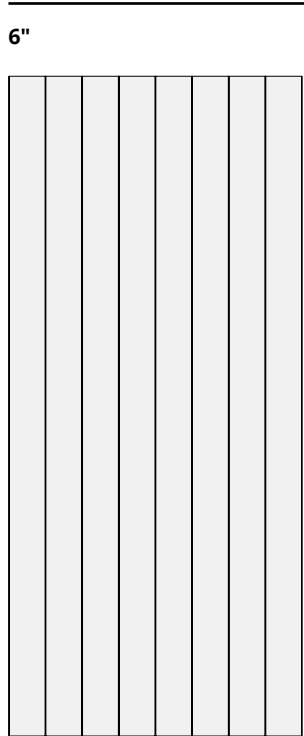
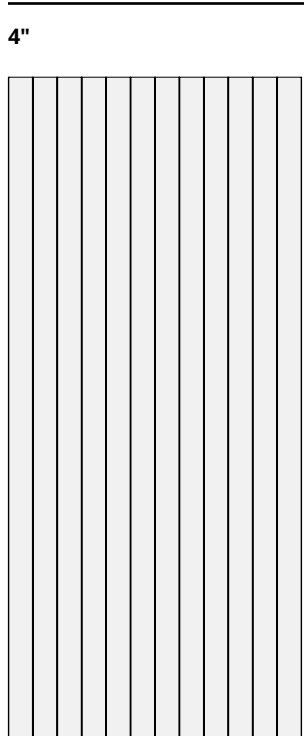
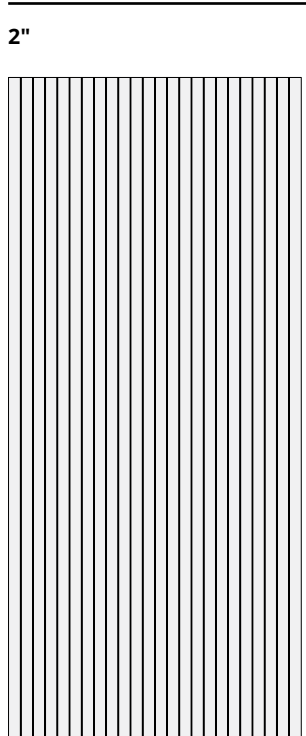
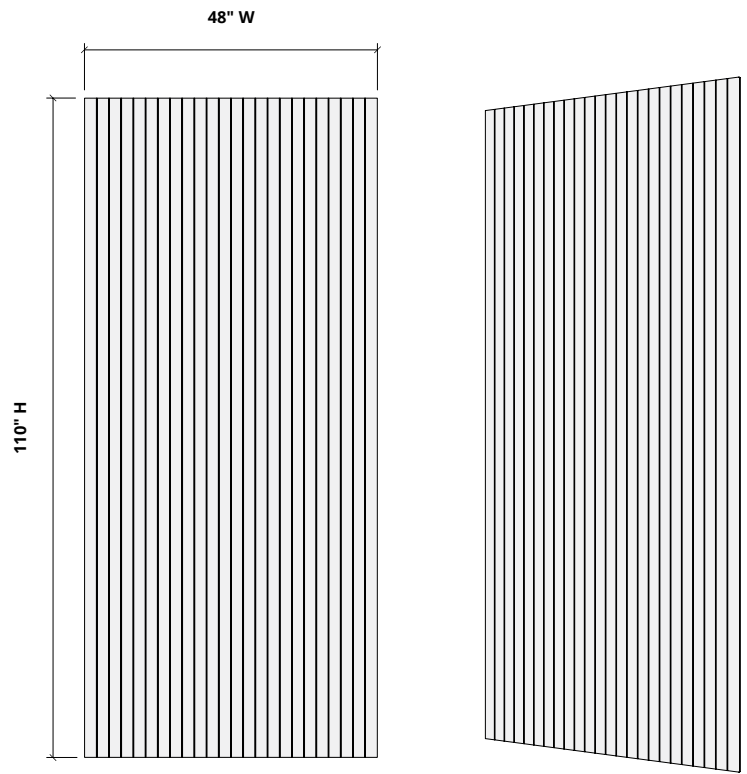

# Colorways

## WOODGRAIN



Boat Shed  
WQ02

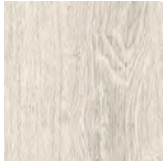

Picket Fence  
WQ01

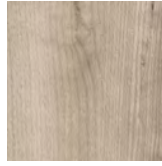

Loft  
WQ06

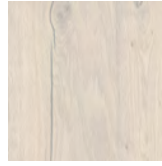

Nordic Plank  
WQ15



White Oak  
WQ13



Baltic Birch  
WQ12



White Elm  
WQ07



Lyed Larch  
WQ30



Woodland Fog  
WQ22

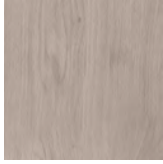

Weathered Slate  
WQ14

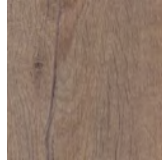

French Bobbin  
WQ08



Boardwalk  
WQ10

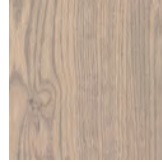

Mountain Lodge  
WQ24

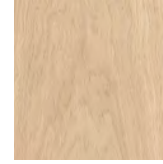

Wine Barrel  
WQ03

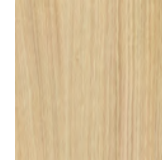

Natural Oak  
WQ16



Knotty Spruce  
WQ29



Shadow Oak  
WQ28



Driftwood  
WQ21



Mocha Legno  
WQ25



Teak  
WQ18

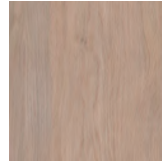

Fumed Oak  
WQ19



European Larch  
WQ17



Petrified Ash  
WQ23



Log Cabin  
WQ04

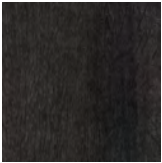

Charred Larch  
WQ09



Barn Door  
WQ05

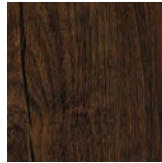

Antique Chest  
WQ11

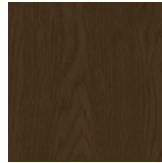

Scorched Timber  
WQ26



Espresso Oak  
WQ27

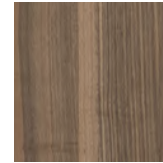

Black Walnut  
WQ20

## V-CUT

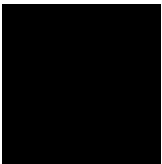

Black

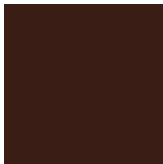

Burnt Umber

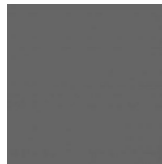

Charcoal



Dark Taupe



Deep Brown

Order samples at [acoufelt.com/colorways](https://acoufelt.com/colorways)

# How to Specify

## 1. Choose V-cut Size

## 2. Choose Colorways

Slats are available in four v-cut sizes:



2" O.C.

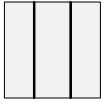

4" O.C.

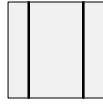

6" O.C.

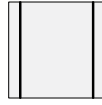

8" O.C.

## 1. Choose V-cut Size

## 2. Choose Colorways

Select one colorway for your slats and one colorway for your v-cut.  
See colorway choices on page 4.

**Slats**  
Select one colorway

**V-cut**  
Select one colorway

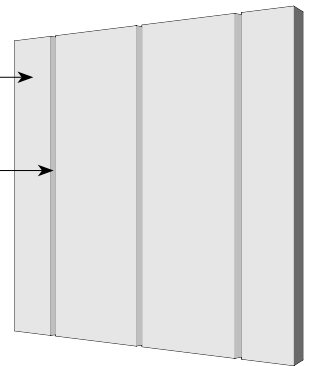

## Color + V-cut Examples



2"W Slats  
Loft + Dark Taupe V-cut



4"W Slats  
French Bobbin + Burn Umber V-cut



6"W Slats  
Boardwalk + Deep Brown V-cut



8"W Slats  
Barn Door + Black V-cut



Call **800.966.8557** with questions or visit **acoufelt.com** for more product information, downloads, and colorways.

# Mounting Methods

## Adhesive backing

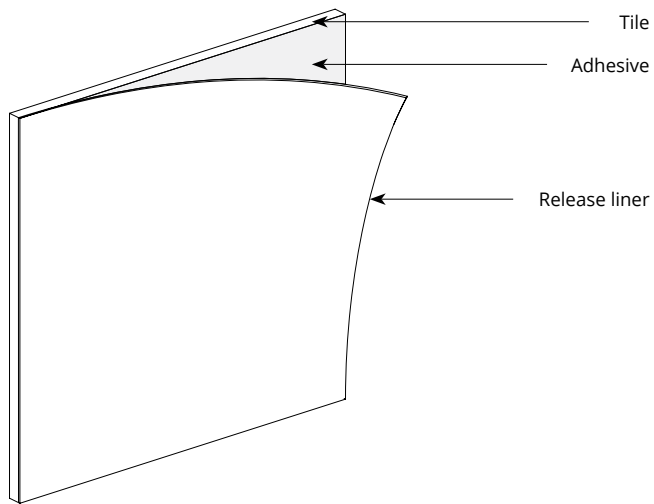

## Construction adhesive

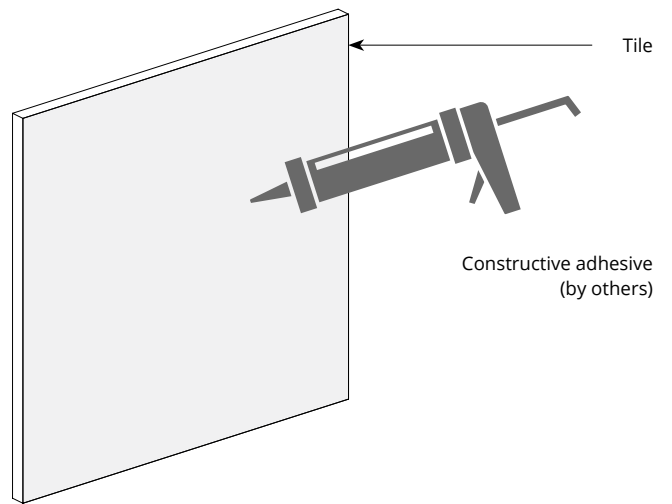

## Z-clip wall mount

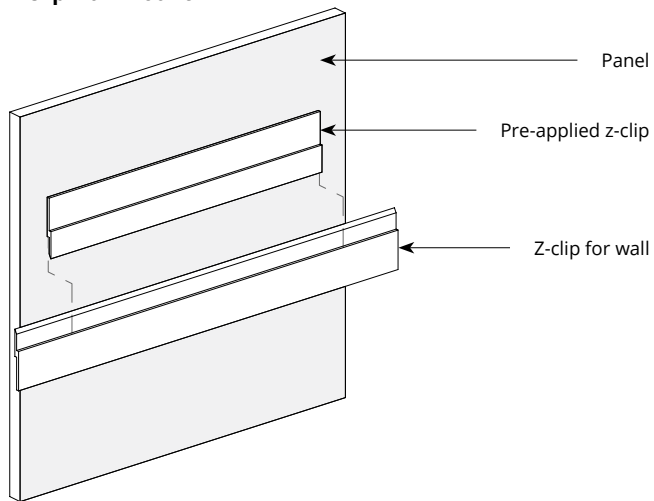

# Acoustic Performance

<b>Test Method</b>	12mm: ASTM C423-09a 24mm: ASTM C423-17
<b>Install Method</b>	A
<b>Rating Method</b>	AS ISO 11654-2002
<b>Test Results</b>	<p><b>12mm</b>                      NRC 0.45, no air gap                      NRC 0.54, 12mm air gap                      NRC 0.64, 20mm air gap                      SAA 0.43, no air gap                      SAA 0.54, 12mm air gap</p> <p><b>24mm</b>                      NRC 0.60, no air gap                      SAA 0.55, no air gap</p>

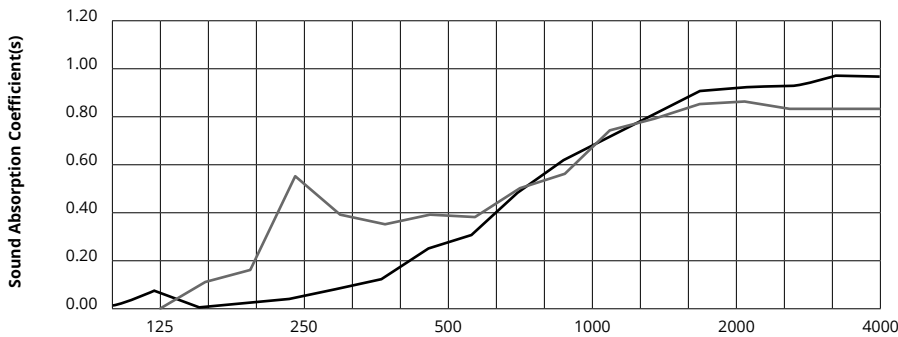

Frequency f (Hz)	125	250	500	1000	2000	4000	NRC
<b>12mm</b>	0.06	0.02	0.23	0.61	0.89	0.95	<b>0.45</b>
<b>24mm</b>	0.02	0.57	0.41	0.58	0.87	0.85	<b>0.60</b>

## What is a Noise Reduction Coefficient (NRC)?

You'll find the NRC rating in the specifications of all of our products. This acronym stands for Noise Reduction Coefficient, and is expressed as a single number, a rating that describes the degree to which acoustic products can absorb sound.

You can use NRC values to understand the overall performance of our acoustic wall and ceiling products. The higher the NRC, the better the product is at soaking up the sound.

*Performance Indices: Noise Reduction Coefficient (NRC) results represent the absorption coefficients measured at the one third octave bands at 125, 250, 500, 1000, 2000 and 4000 Hz rounded to the nearest 0.05. Acoustic testing has been performed according to the methods mentioned above. Customization of installation of the product could alter the results. Sound Absorption Average (SAA) indicates the absorption coefficient average for the twelve one-third octave bands ranging between 200 and 2500 Hz.*