



Step Ceiling Baffle

FilaSorb™ 12

acoufelt
making quiet

Product Detail

| | | |
|------------------|-------------------------------------|-----|
| Product | Step Ceiling Baffle | |
| Surface | Ceiling | |
| Composition | 100% Polyester | |
| Material | FilaSorb™ | |
| Recycled Content | 60% min. | |
| Thickness | 12mm 0.47" +/- 10% | |
| Weight | 0.49 lb/ft ² +/- 10% | |
| Lengths | 48" or 60" or 96" or 108" | |
| Depths | A | B |
| | 4" | 8" |
| | 5" | 10" |
| | 6" | 12" |
| | Custom size available upon request. | |

Technical Data

| | |
|-------------------------|---|
| Fire Test Method Number | AS ISO 9705:Group 1 ASTM E84-17a Class A |
| Indoor Air Quality | Low VOCs emission, formaldehyde and Phenol-free |
| Light Fastness | ISO 105-B02 1994, 6-7 |

Acoustic Performance

Sound Absorption ASTM C423 with an ASTM E795 type "J" Mounting
NRC 0.75 (12mm x 8"D with 6"O.C.)

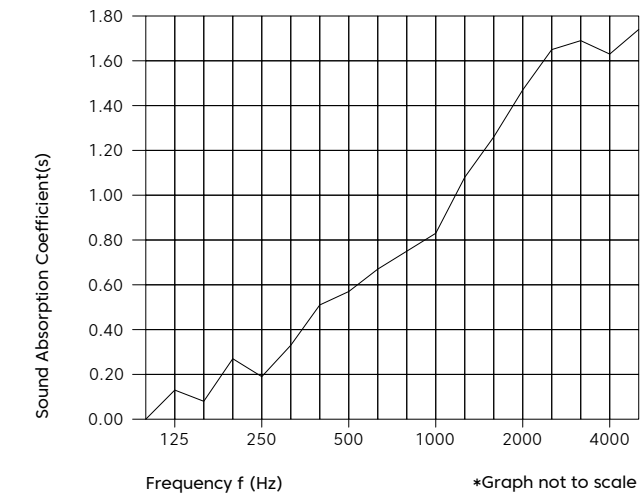

| Frequency f (Hz) | 125 | 250 | 500 | 1000 | 2000 | 4000 | NRC |
|---------------------|--|------|------|------|------|------|------|
| 12mm α _s | 0.13 | 0.19 | 0.57 | 0.83 | 1.47 | 1.63 | 0.75 |
| 24mm α _s | Product acoustic performance testing is in progress. | | | | | | |

Guarantees

| | |
|-------------------------|--------------------|
| Lead Time | Ships in 4-6 weeks |
| Light Fastness Warranty | 10 Years* |
| Customizable | Yes |

* conditions apply

Environmental Attributes

- Declare Certification
- LCB Red List Free
- Phenol And Formaldehyde Free
- Low VOC
- CDPH Compliance
- Aligns With Building Standards



Specifying Process

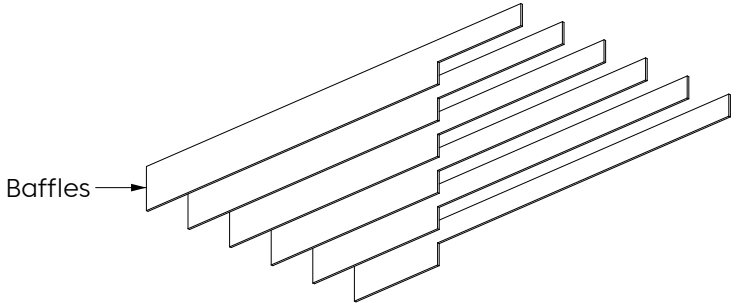
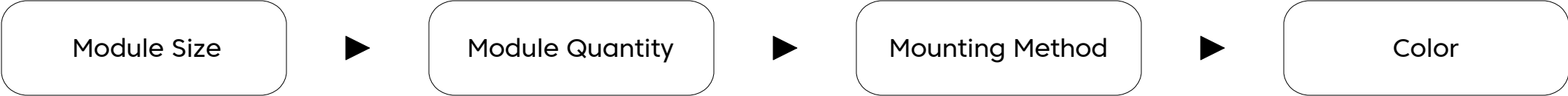

Choose Your Option See following pages for details.

| | | | | | | |
|--------------------|--|------------------------|--|--|--|--------------|
| Module Size | | Module Quantity | | Mounting Method | | Color |
| 108"W x 4" - 8"D | | Single Module | | Cable Cable To Deck Cable To T Grid | | |
| 108"W x 5" - 10"D | | | | Swivel Cable To Deck Cable To Unistrut Threaded Rod | | |
| 108"W x 6" - 12"D | | | | Threaded Rod To Unistrut Twist Lock To T Grid Magnet To T Grid | | |
| | | | | Direct Mount To Unistrut | | |

Design

Elevation

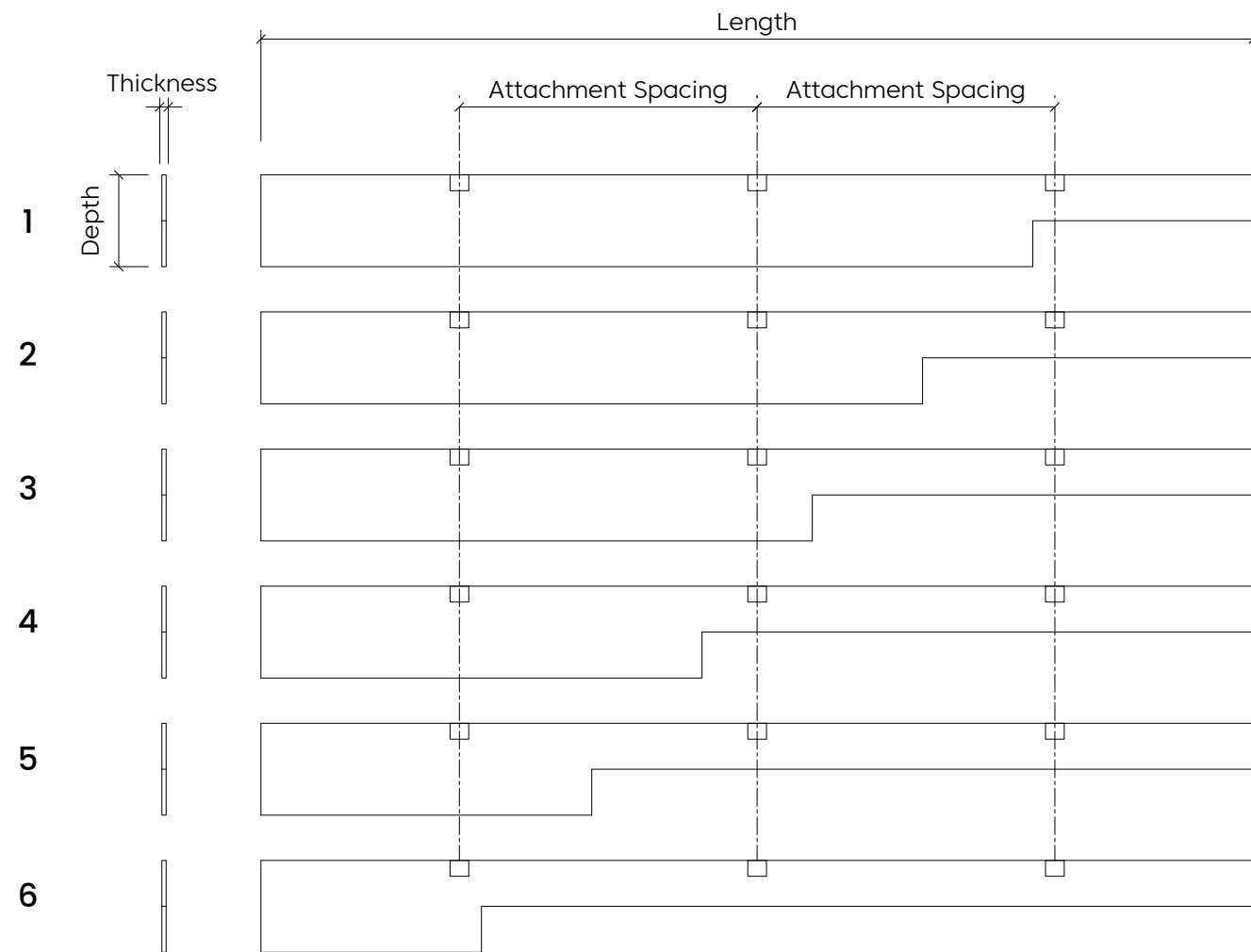

Perspective

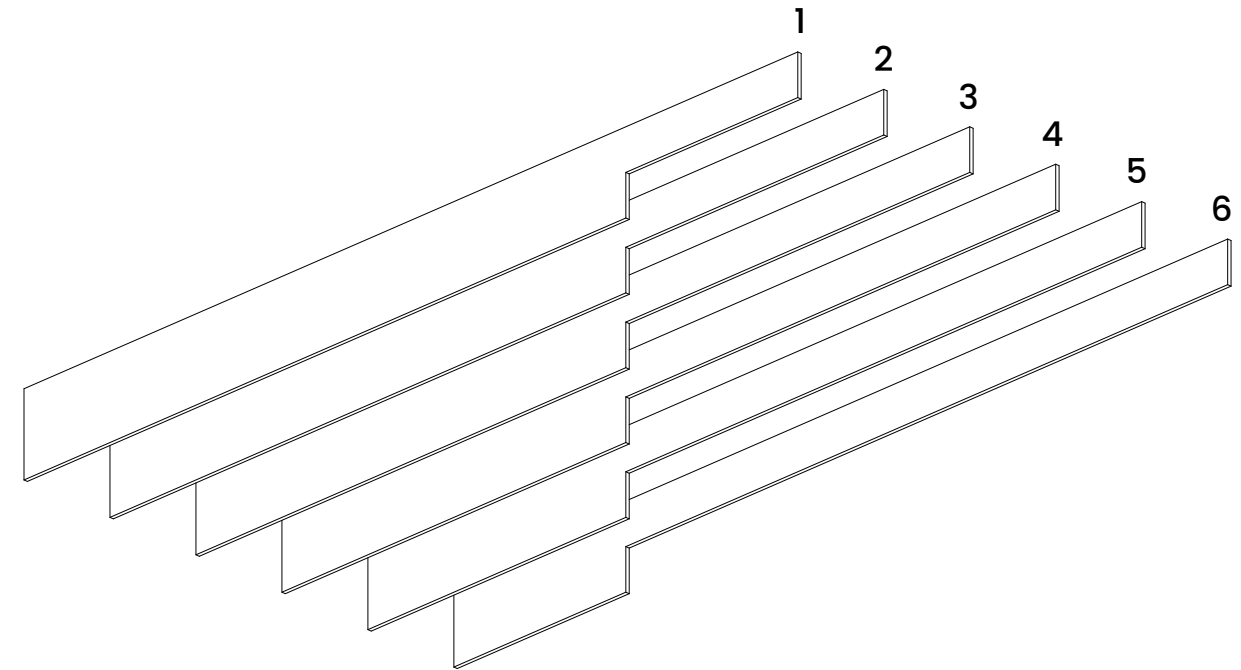

* Number of connections may vary depending on length

Design

Module Size



Module Quantity



Mounting Method



Color

Elevation

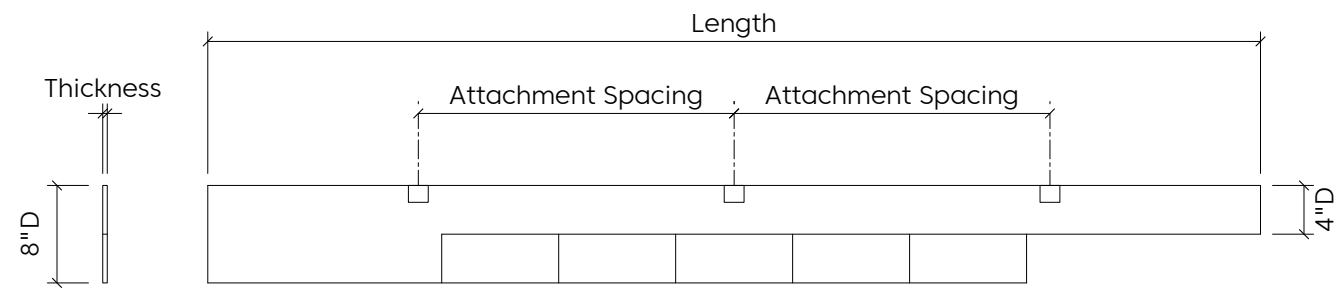

Elevation

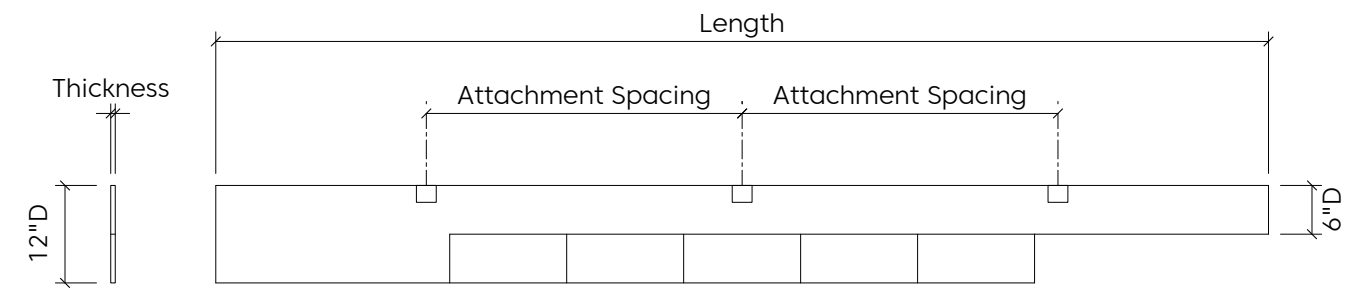

Elevation

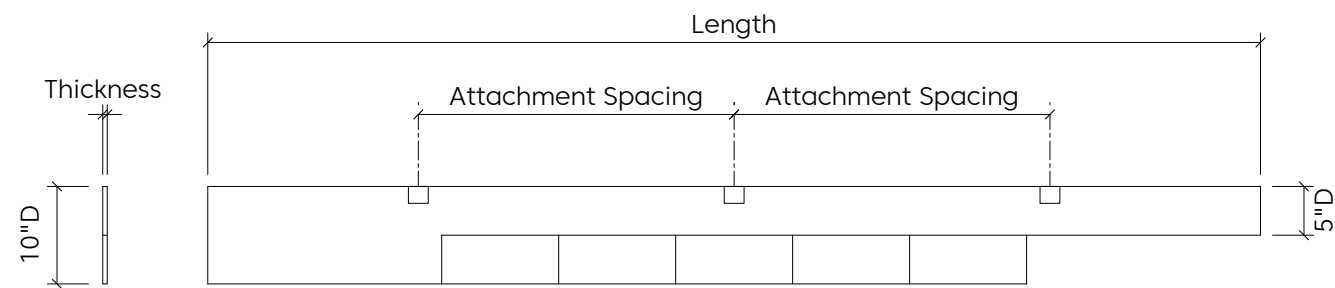

* Number of connections may vary depending on length

Single Module



Plan

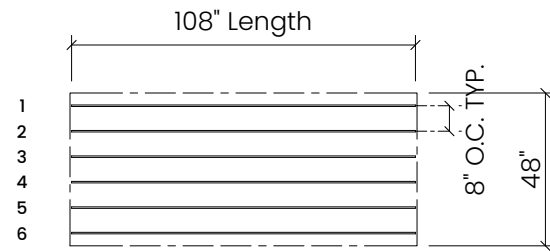

Perspective

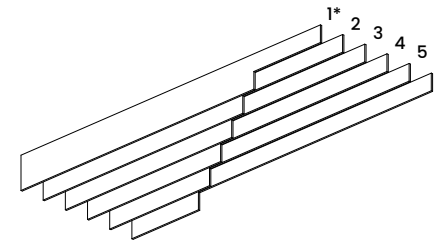

* Baffle sequence.

Multiple Modules

Plan



Perspective

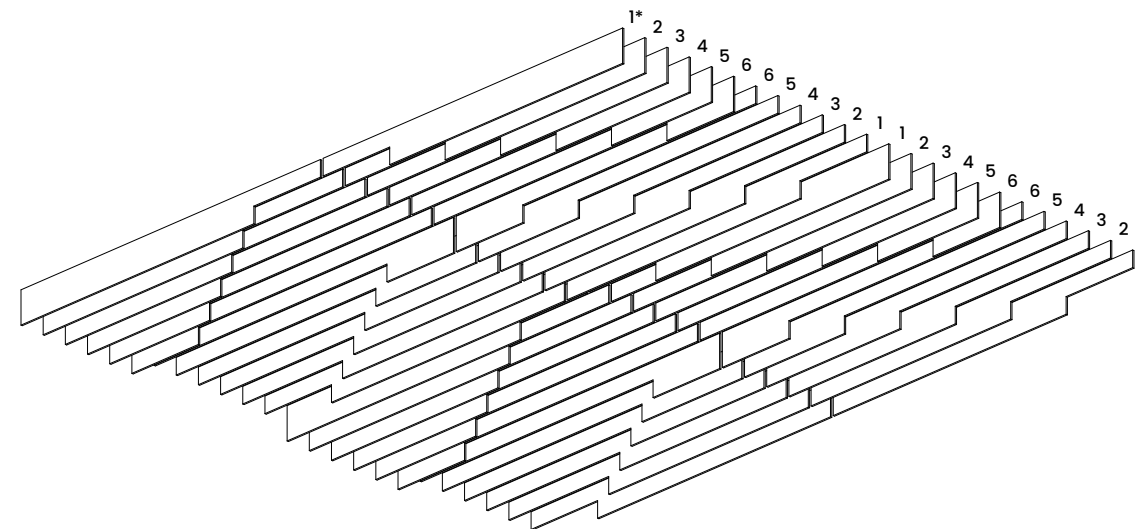

Layout Guide

Standard Layout

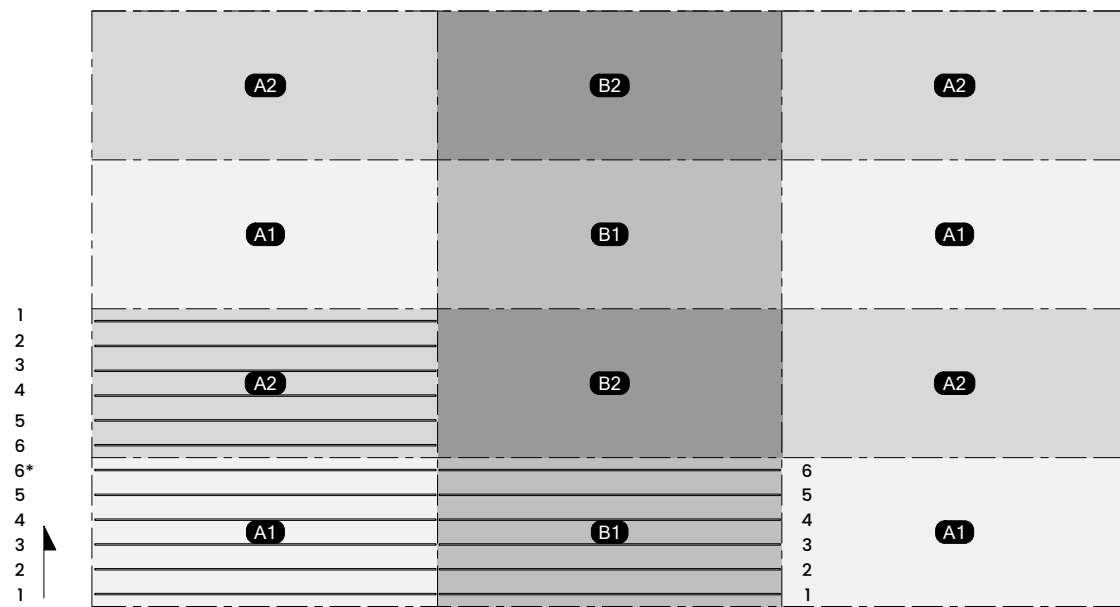

* Refer to pg.4 for baffle design.

Perspective

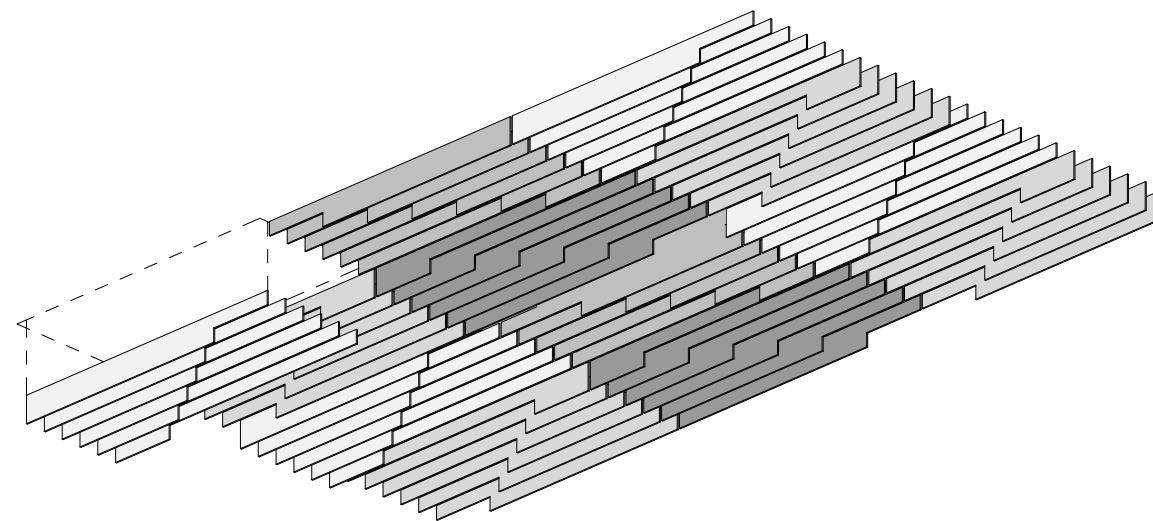

*Colors shown on this page are for color coding only. Refer to pg. 9 for felt colorways.

Module Perspective

Module A1

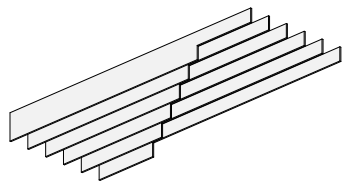

Module B1

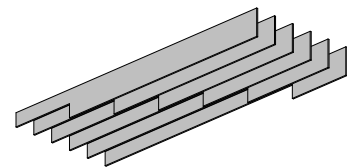

Module A2

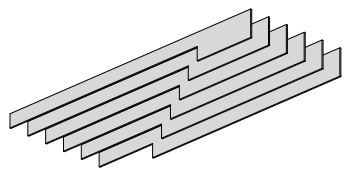

Module B2

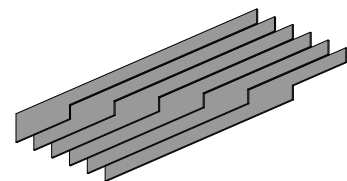

Front Perspective

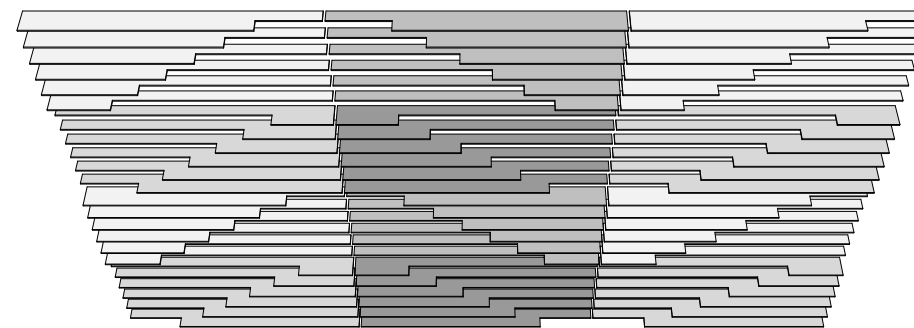

Mounting Methods

Module Size

Module Quantity

Mounting Method

Color

Cable

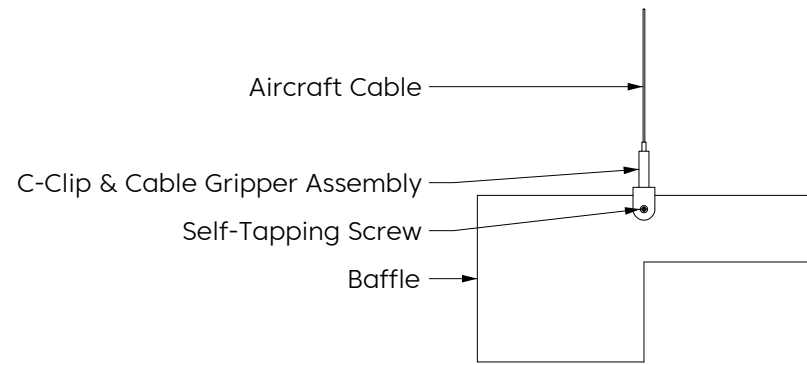

Cable To Deck

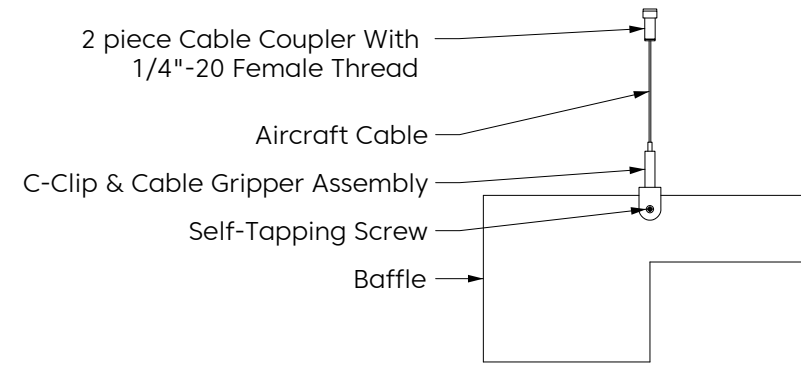

Cable To T Grid

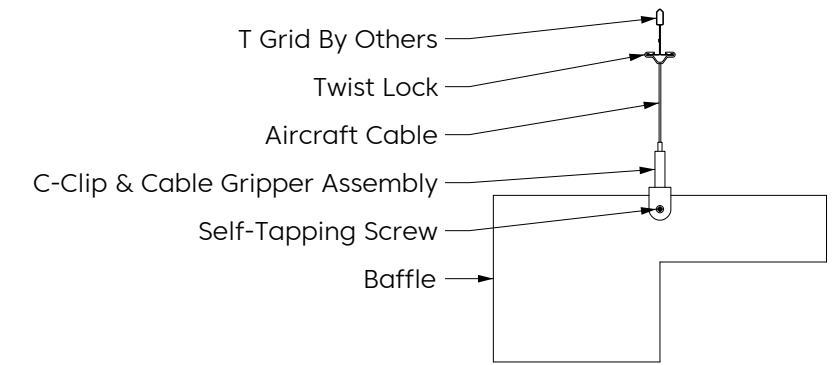

Cable To Unistrut

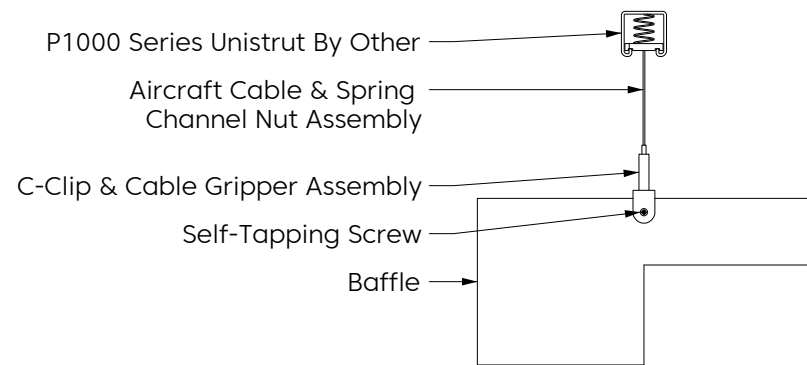

Swivel Cable To Deck

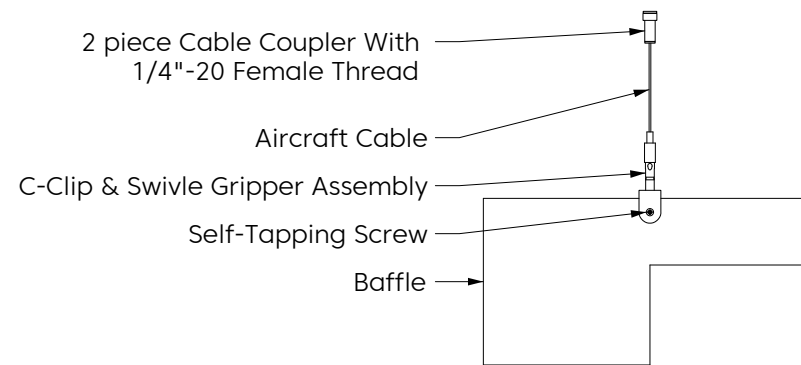

Magnet To T Grid

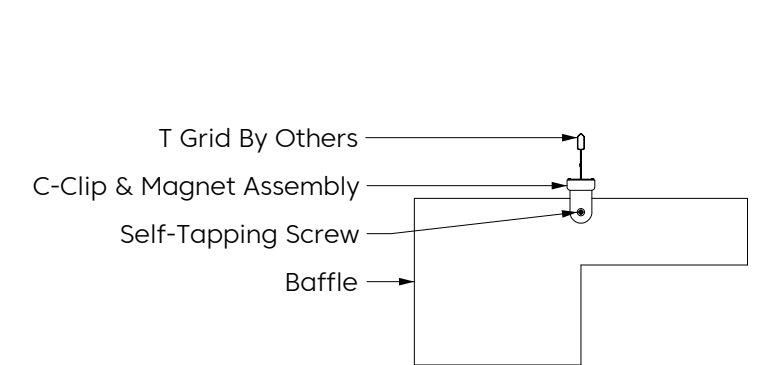

Mounting Methods



Threaded Rod

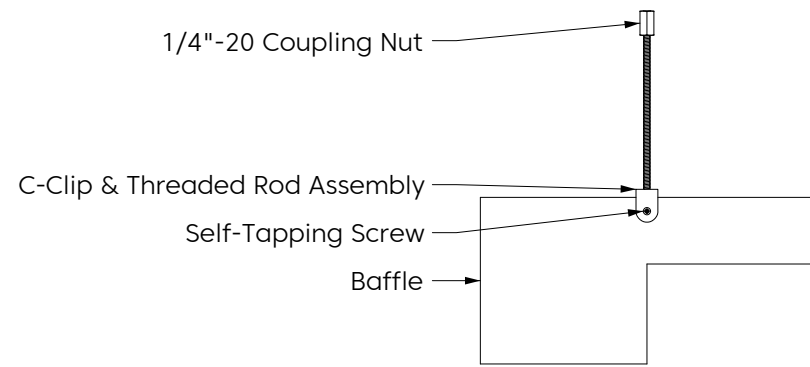

Threaded Rod To Unistrut

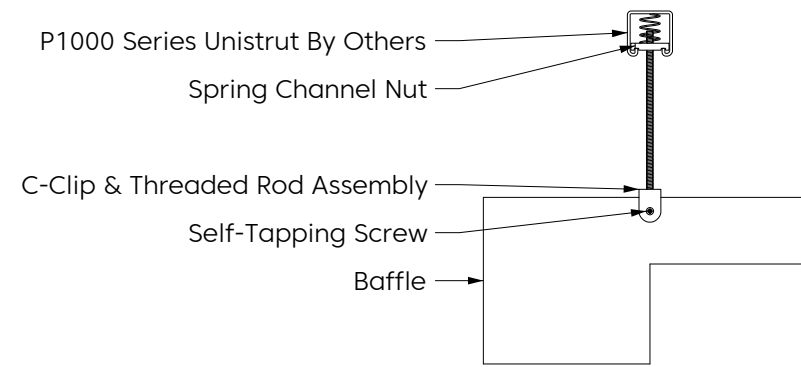

Direct To Unistrut

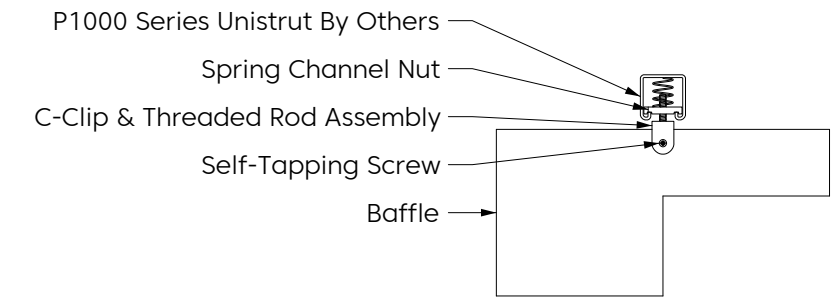

Twist Lock To T Grid

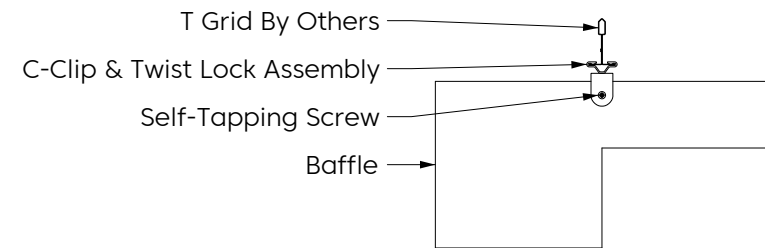

Colorways

Module Size

Module Quantity

Mounting Method

Color



Lipstick Red
LI14



Carrot
CA08

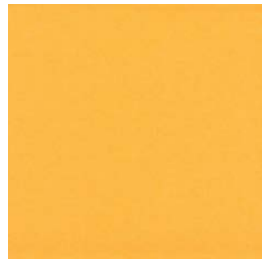

Butter
BU07

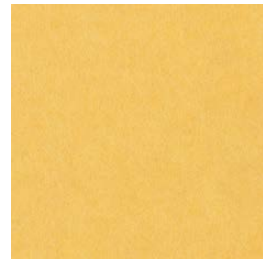

Popcorn
PO26



Pistachio
PI25

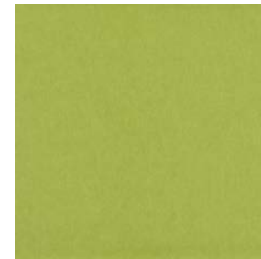

Wasabi
WA29



Thistle
TH28

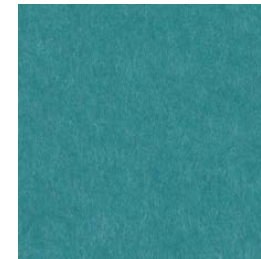

Peacock
PE20



Oregano
OR18



Kale
KA12



Denim
DE09



Midnight
MI16



Azur
AZ05



Marine
MA15



Periwinkle
PE23



Iris
IR10



Berry
BE06



Lilac
LI13

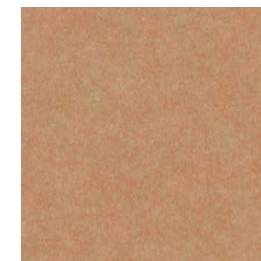

Peach
PE19



Peppercorn
PE22



Piano Black
PI24



Charcoal
CH01

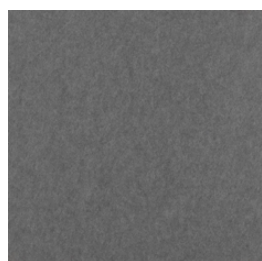

Slate
SL27



Grey
GR02



Metal
ME03



Platinum
PL04



White
WH12



Pearl
PE21



Ivory
IV11