

FilaSorb™ 24

acoufelt  
making quiet

# Product Detail

Product	Groove Ceiling Baffle
Surface	Ceiling
Composition	100% Polyester
Material	FilaSorb™
Recycled Content	60% min.
Material Thickness	24mm   0.94" +/- 10%
Weight	0.98 lb/ft <sup>2</sup> +/- 10%
Standard Dimensions	See page 4 for size offerings. Custom size available upon request.
Lead Time	Ships in 4-6 weeks
Light Fastness Warranty	10 Years*

\* conditions apply

# Technical Data

Fire Test Method Number	AS ISO 9705:Group 1 ASTM E84-17a Class A
Indoor Air Quality	Low VOCs emission, formaldehyde and Phenol-free
Light Fastness	ISO 105-B02 1994, 6-7

# Acoustic Performance

Product acoustic performance testing is in progress.

# Colorways

[\\* Go To Colorway Page](#)



 Manufactured & Assembled in the USA

# Environmental Attributes

- Declare Certification
- LBC Red List Free
- Phenol And Formaldehyde Free
- Low VOC
- CDPH Compliance
- Aligns With Building Standards



# Groove 1 (GR1)

Elevation

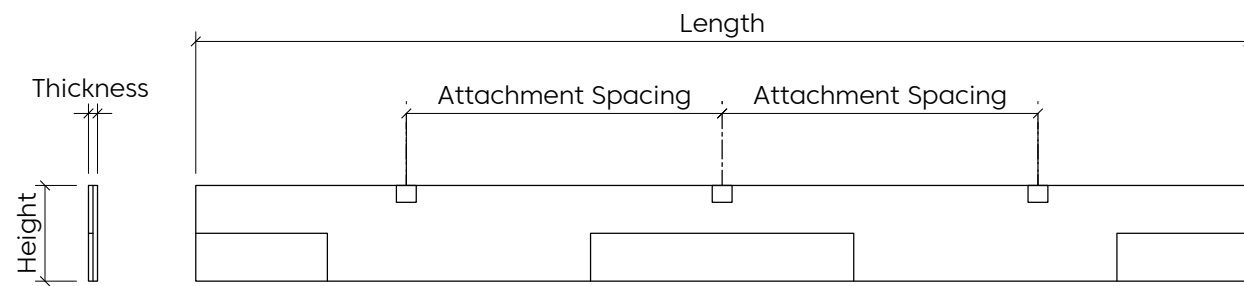

Perspective

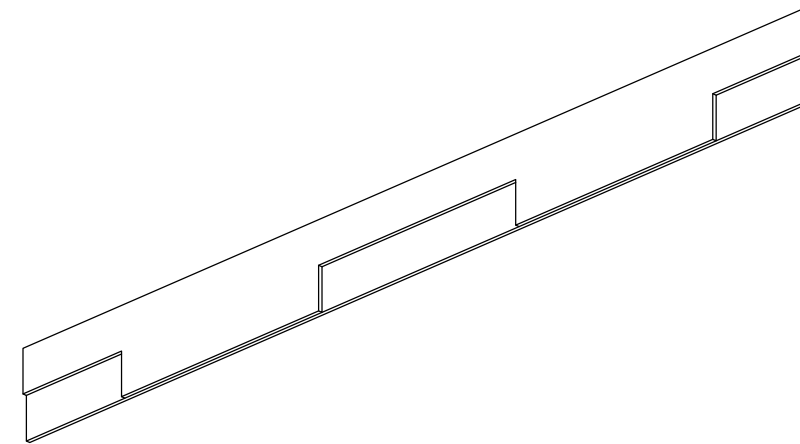

# Groove 2 (GR2)

Elevation

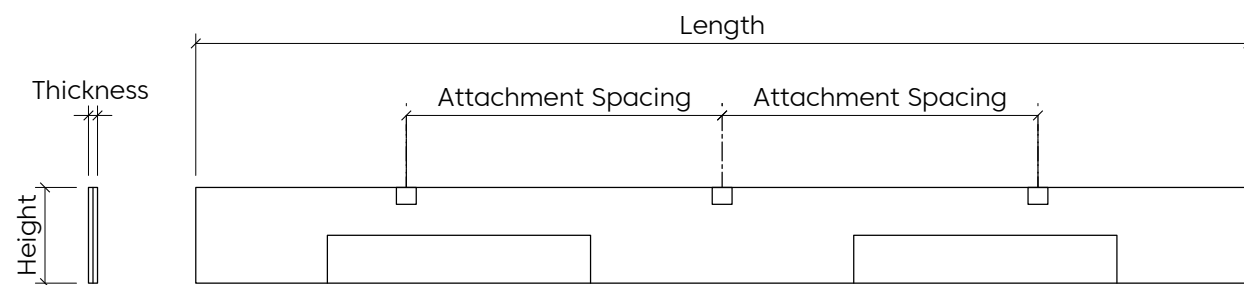

Perspective

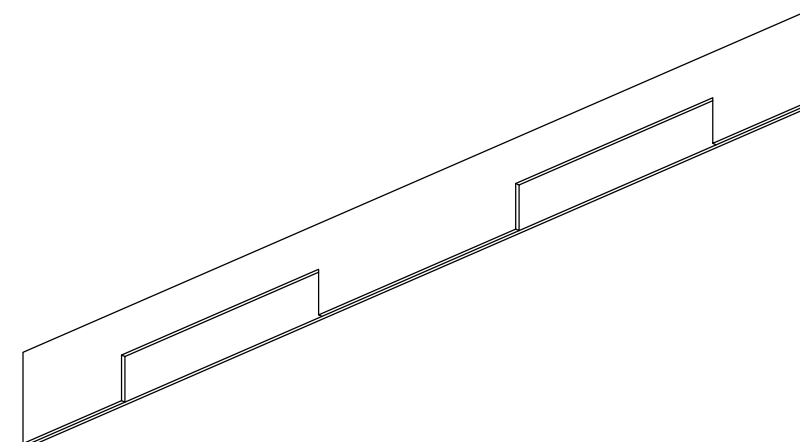

\* Number of connections may vary depending on length

# Design

Elevation

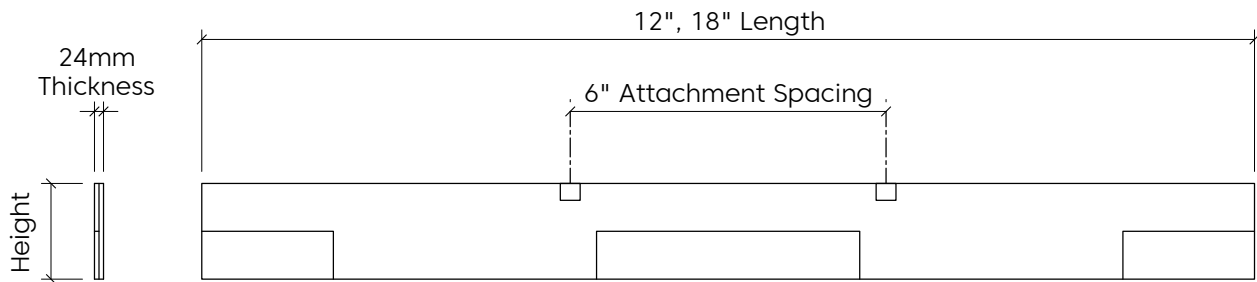

Elevation

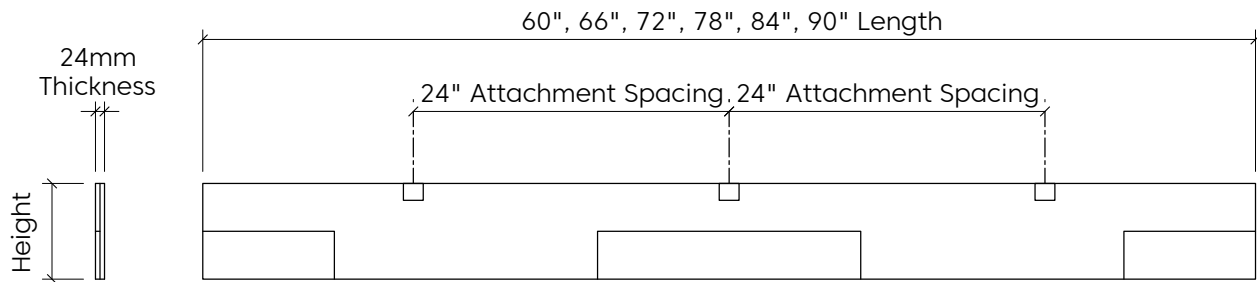

Elevation

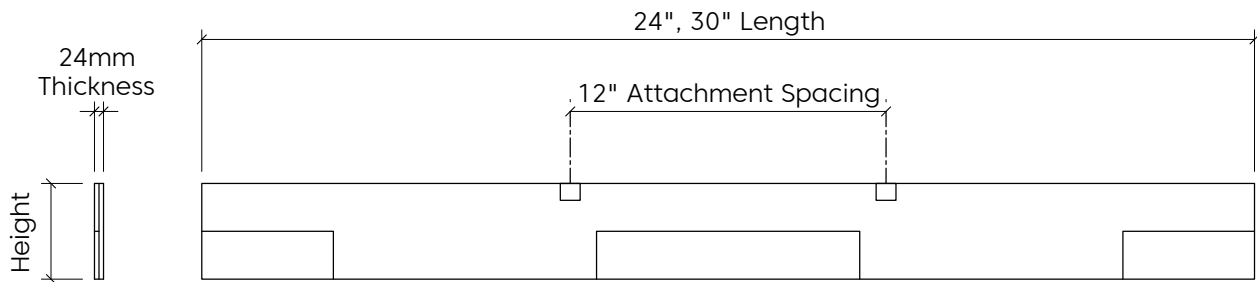

Elevation

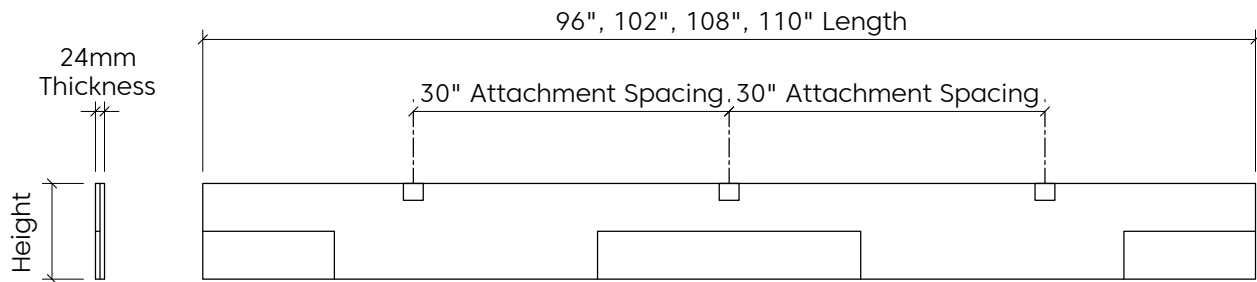

Elevation

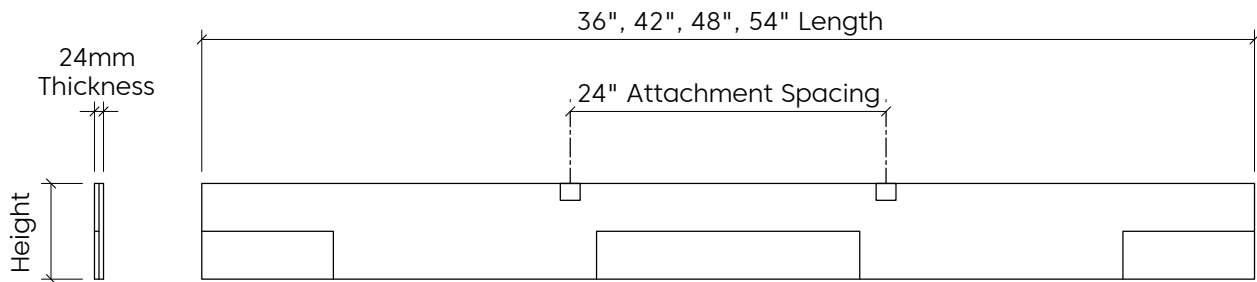

Standard Size Offerings

Standard Heights	
4"	6"
8"	10"
12"	14"
16"	18"
20"	22"
24"	

# Recommended Layouts

---

Layout 1 (100% GR1)

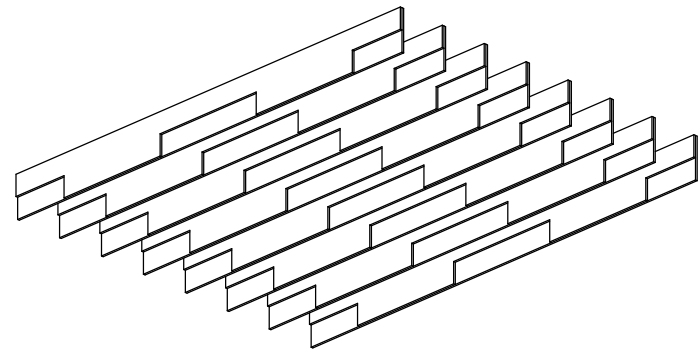

Layout 2 (100% GR2)

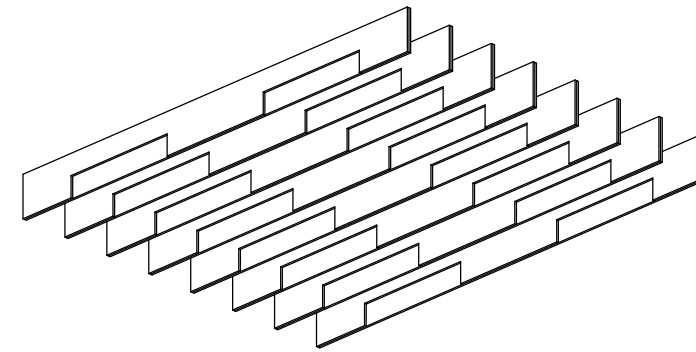

Layout 3 (50% GR1 & 50% GR2)

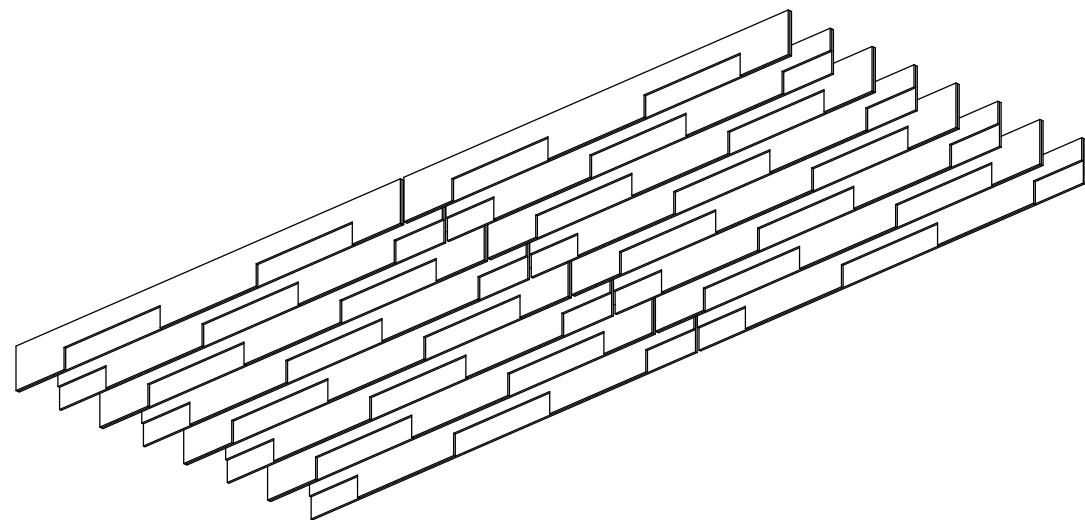

# Mounting Methods

## Cable

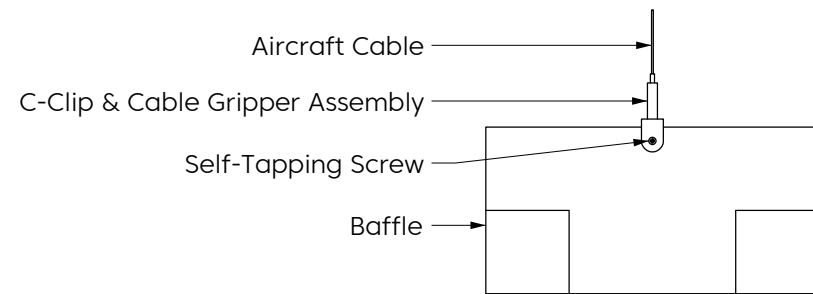

## Cable To Deck

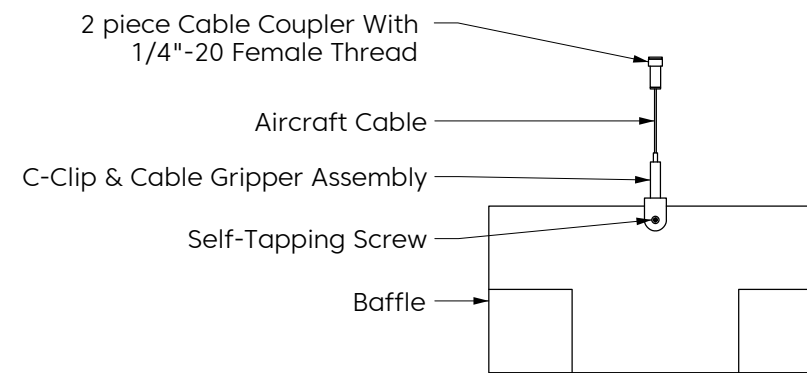

## Cable To T Grid

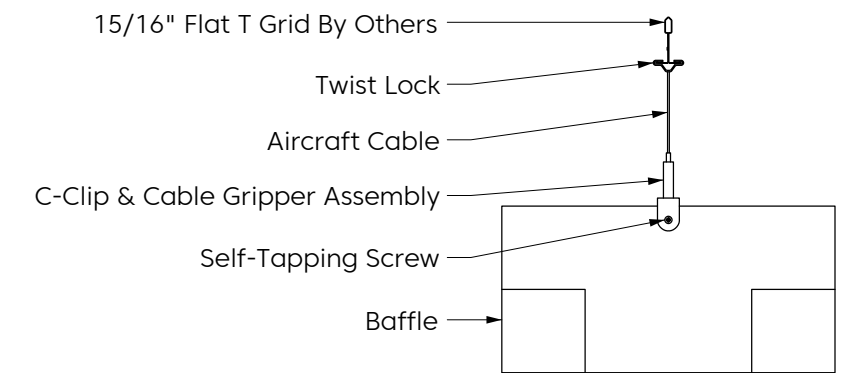

## Cable To Unistrut

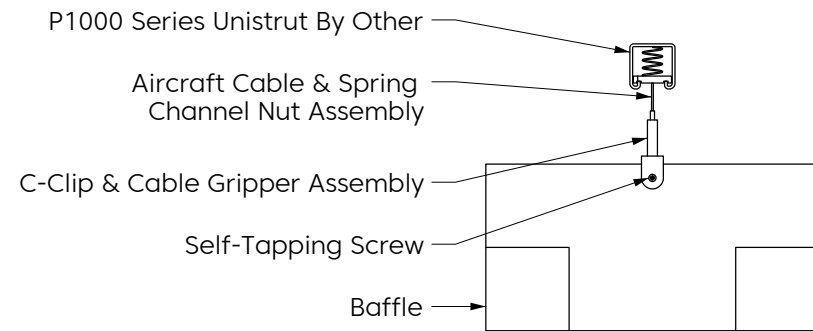

## Swivel Cable To Deck

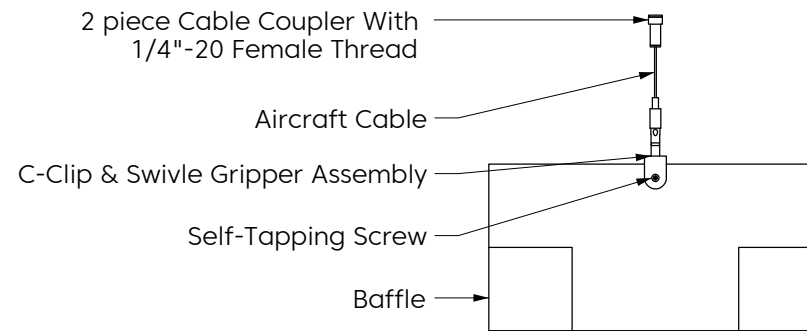

## Magnet To T Grid

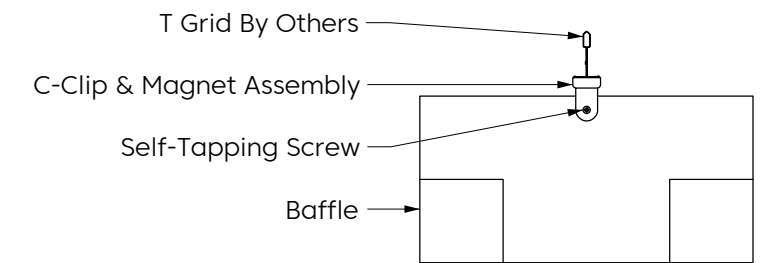

# Mounting Methods

## Threaded Rod

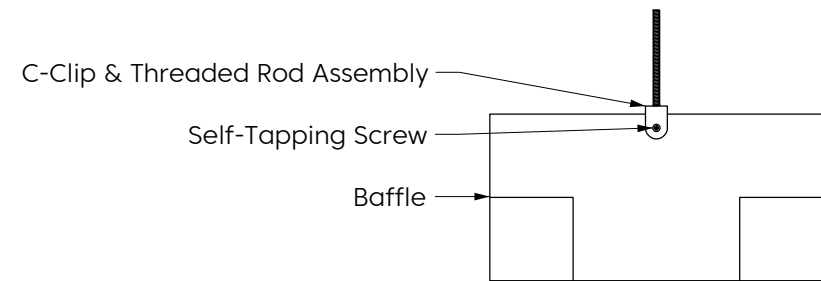

## Threaded Rod To Unistrut

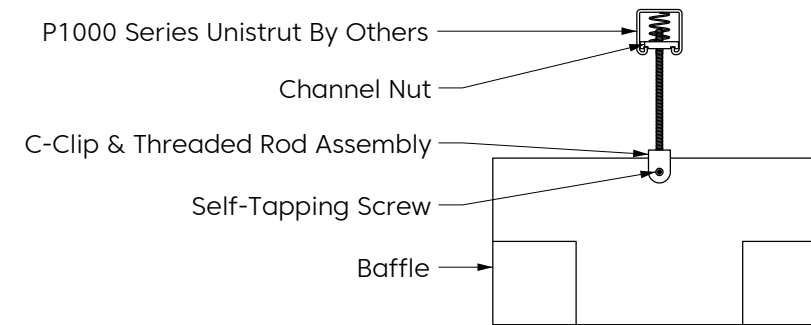

## Direct To Unistrut

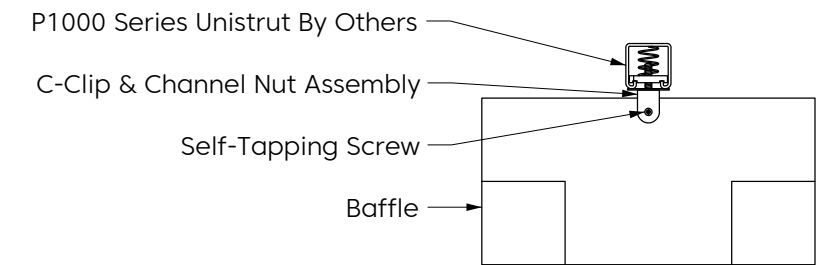

## Twist Lock To T Grid

