



Fan Ceiling Baffle

FilaSorb™ 24

acoufelt
making quiet

Product Detail

Product	Fan Ceiling Baffle
Surface	Ceiling
Composition	100% Polyester
Material	FilaSorb™
Recycled Content	60% min.
Thickness	24mm 0.94" +/- 10%
Weight	0.98 lb/ft ² +/- 10%
Length	48" or 60" or 96" or 110"
Depth	4" Min - 8" Max 5" Min - 10" Max 6" Min - 12" Max Custom size available upon request.

Technical Data

Fire Test Method Number	AS ISO 9705:Group 1 ASTM E84-17a Class A
Indoor Air Quality	Low VOCs emission, formaldehyde and Phenol-free
Light Fastness	ISO 105-B02 1994, 6-7

Acoustic Performance

Product acoustic performance testing is in progress.

Guarantees

Lead Time	Ships in 4-6 weeks
Light Fastness Warranty	10 Years*
Customizable	Yes

* conditions apply

Environmental Attributes

- Declare Certification
- LCB Red List Free
- Phenol And Formaldehyde Free
- Low VOC
- CDPH Compliance
- Aligns With Building Standards



Specifying Process

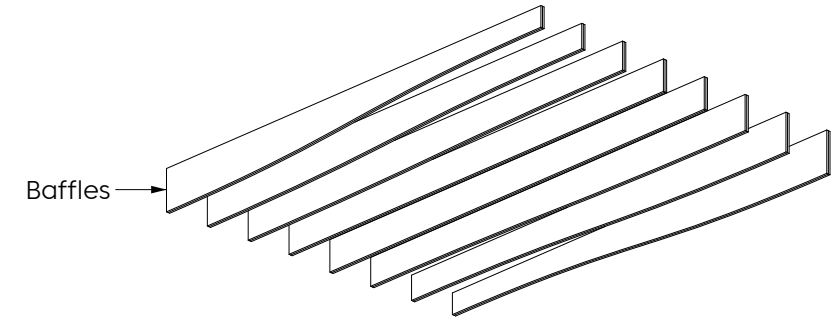
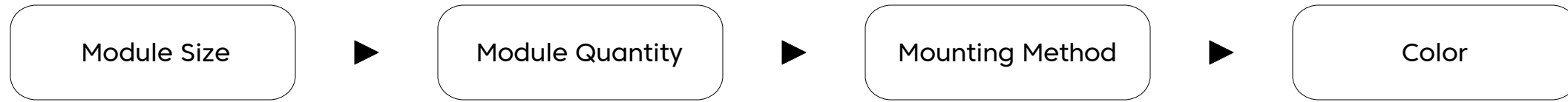

Choose Your Option See following pages for details.

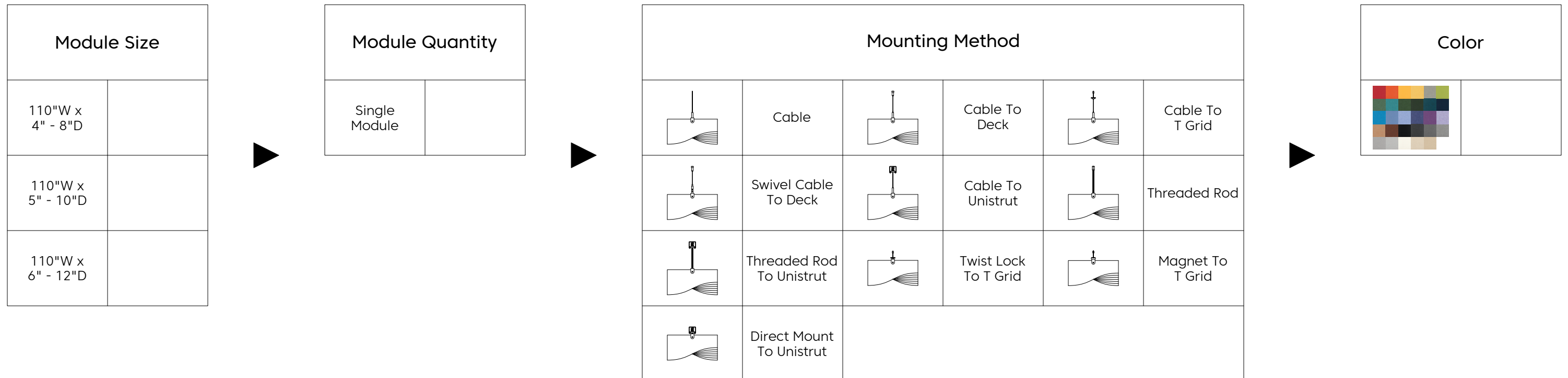

Design

Elevation

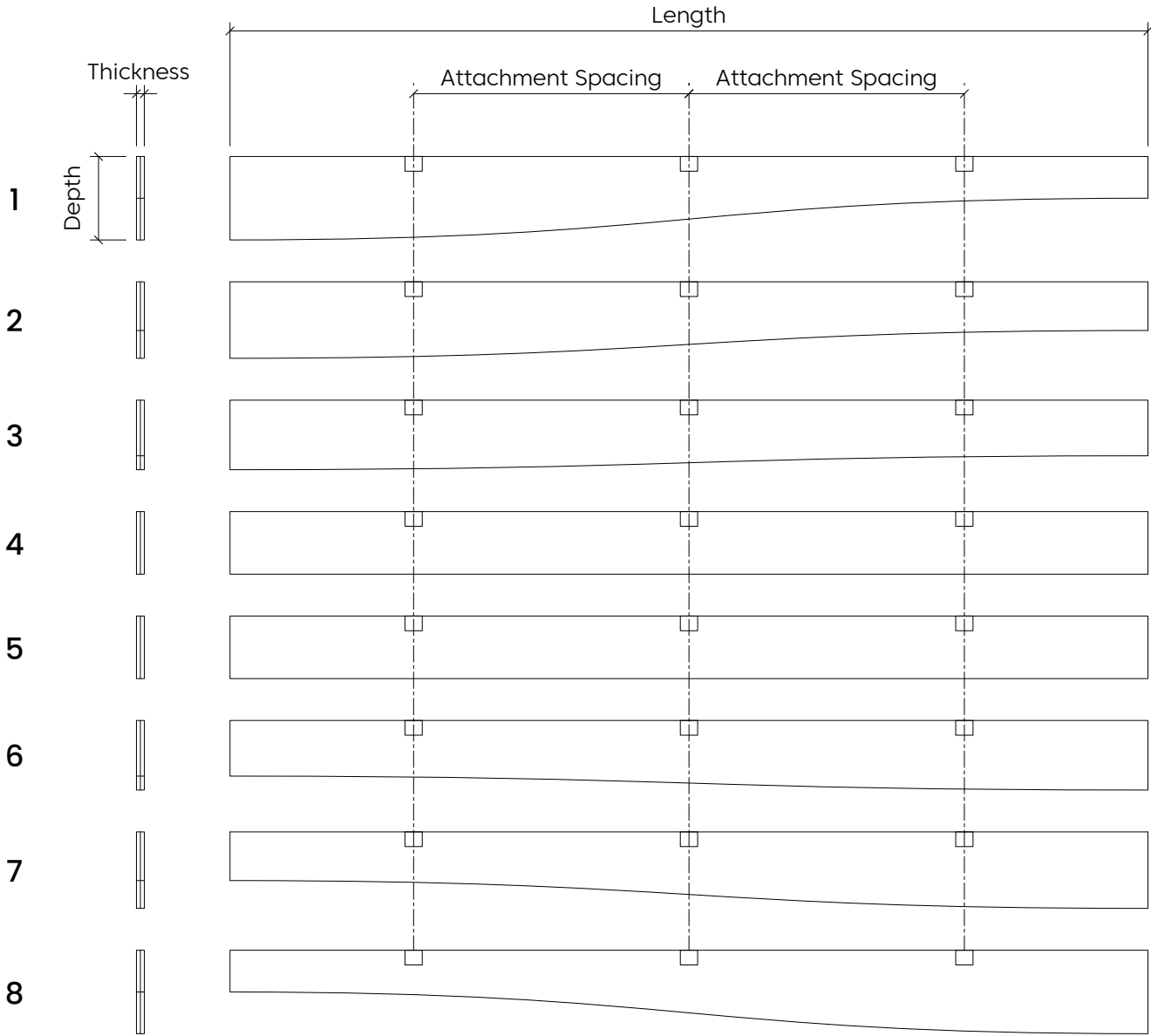

Perspective

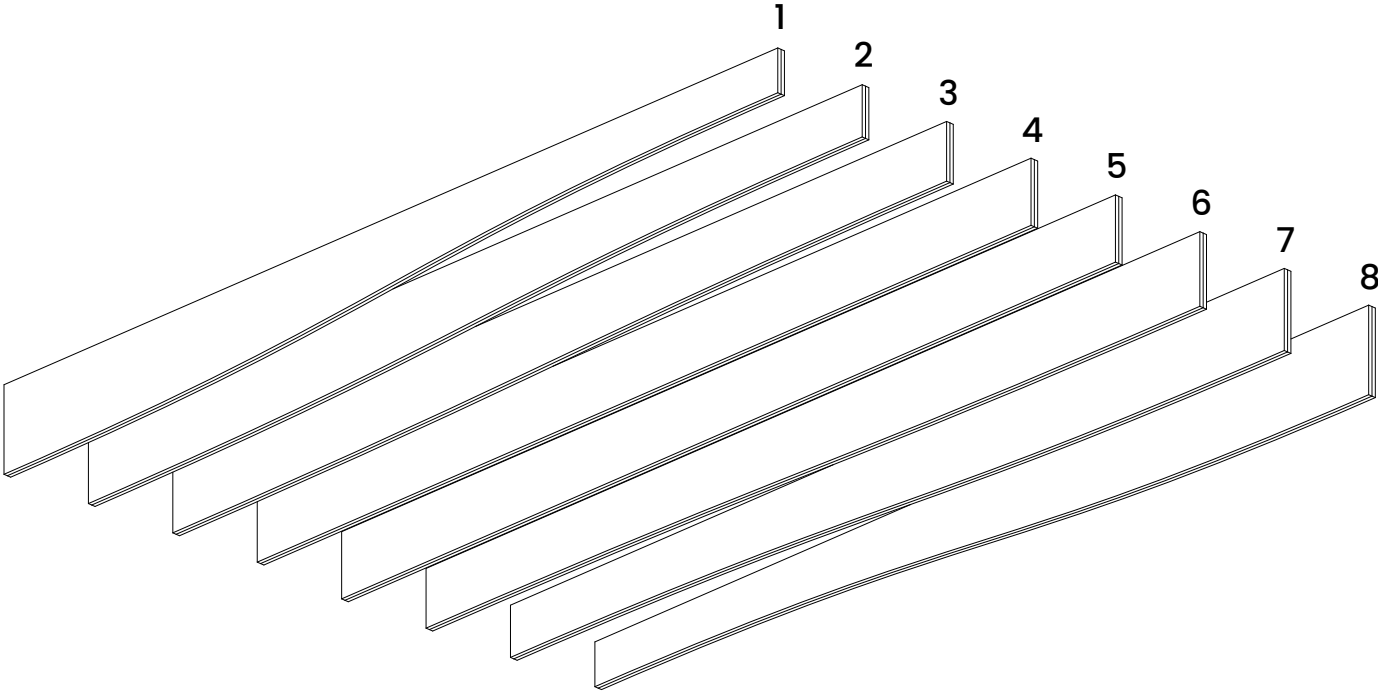

* Number of connections may vary depending on length

Design

Module Size

Module Quantity

Mounting Method

Color

Elevation

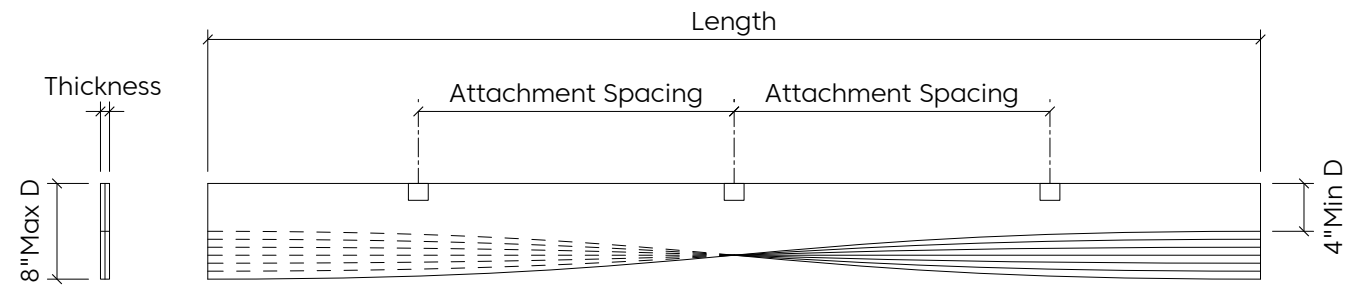

Elevation

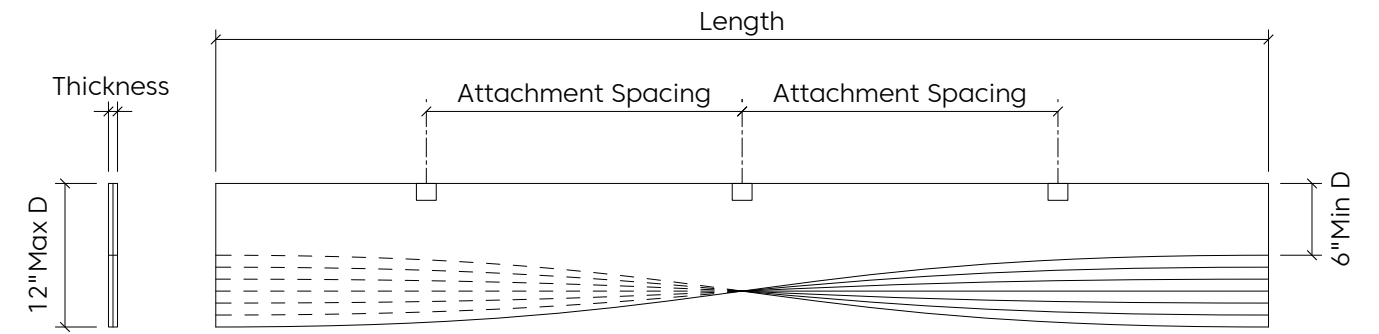

Elevation

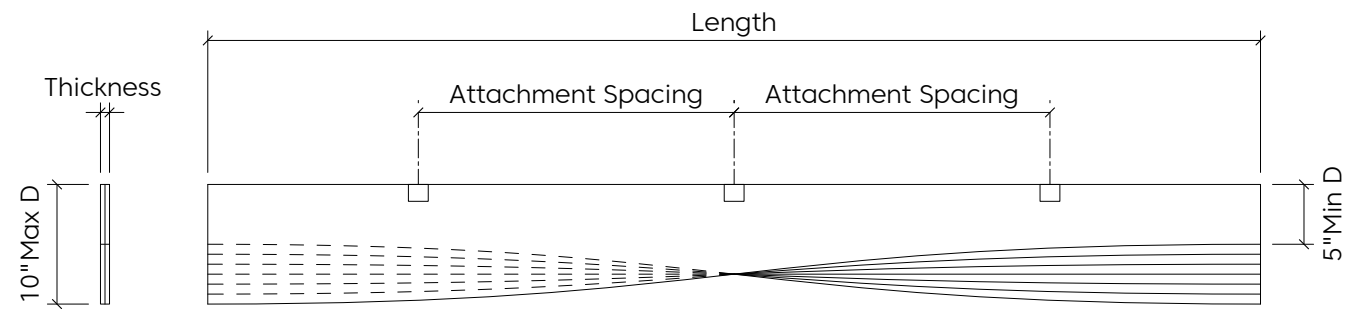

* Number of connections may vary depending on length

Single Module



Plan

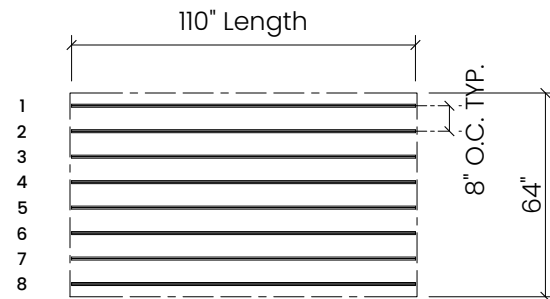

Perspective

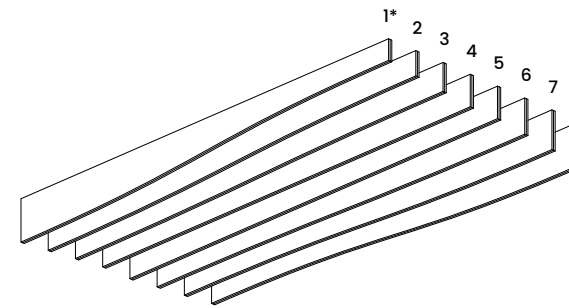

* Baffle sequence.

Multiple Modules

Plan

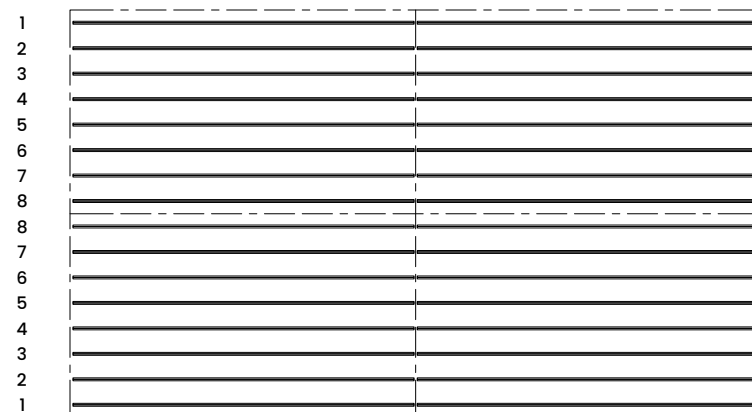

Perspective

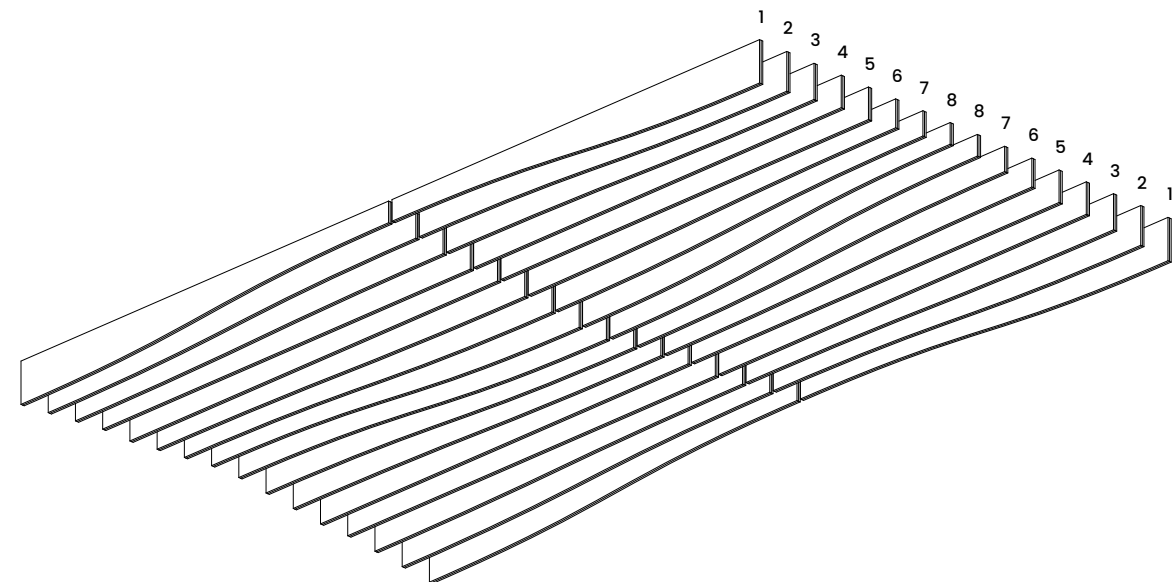

Layout Guide

Module Size ▶
 Module Quantity ▶
 Mounting Method ▶
 Color

Standard Layout

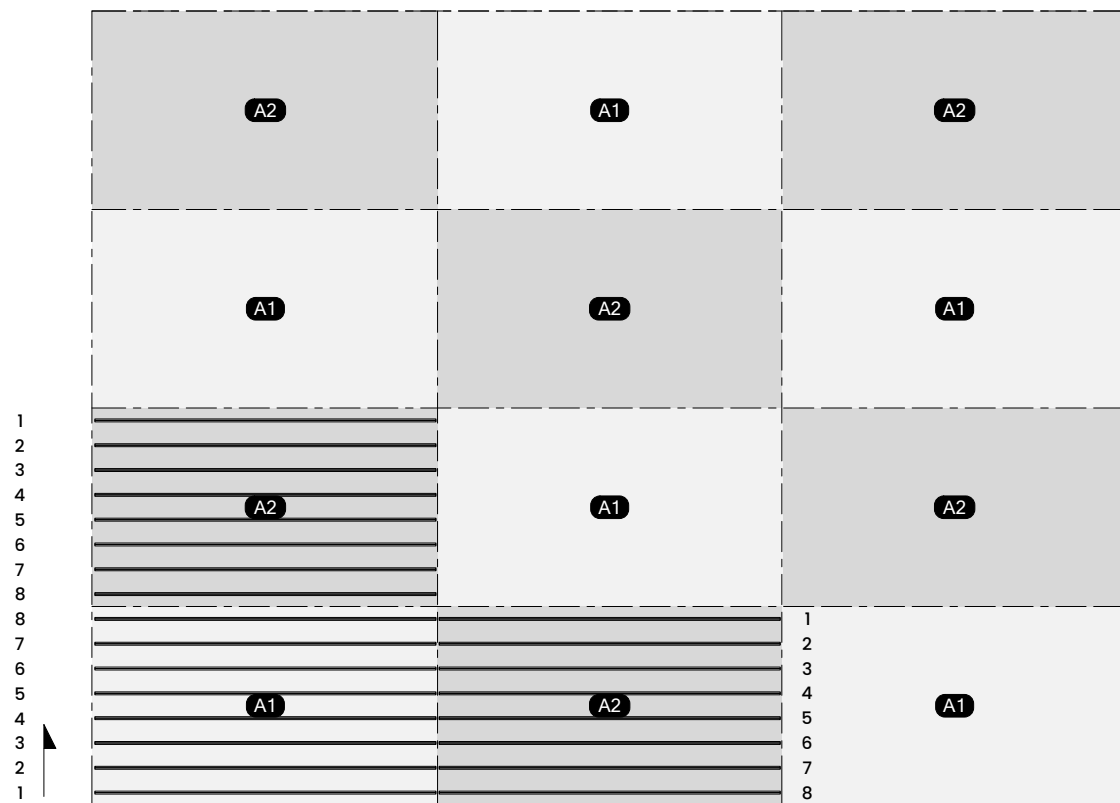

* Refer to pg.4 for baffle design.

Module Perspective

Module A1

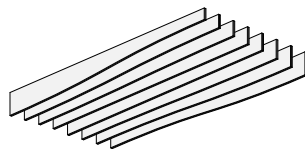

Module A2

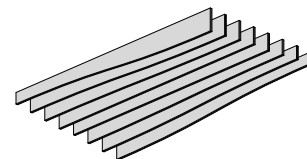

Perspective

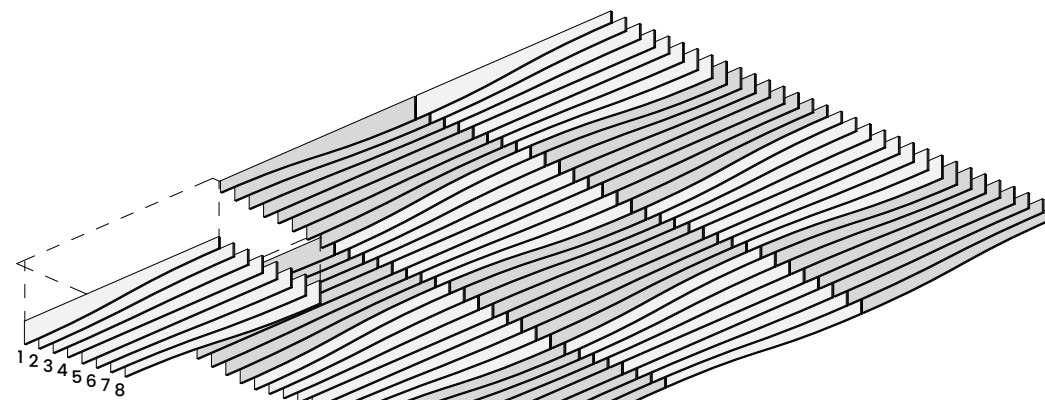

*Colors shown on this page are for color coding only. Refer to pg. 9 for felt colorways.

Front Perspective



Mounting Methods

Module Size

Module Quantity

Mounting Method

Color

Cable

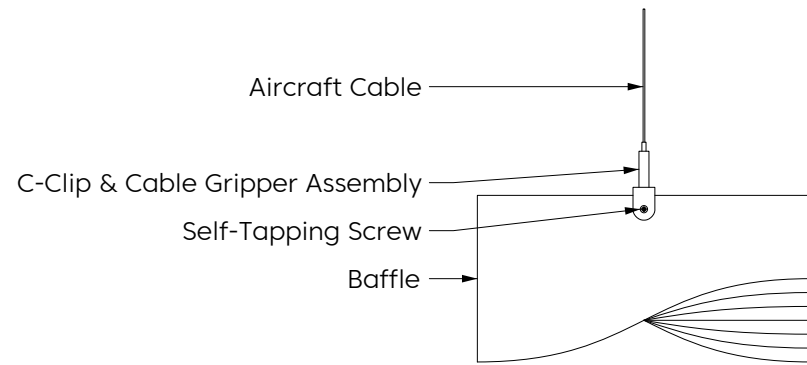

Cable To Deck

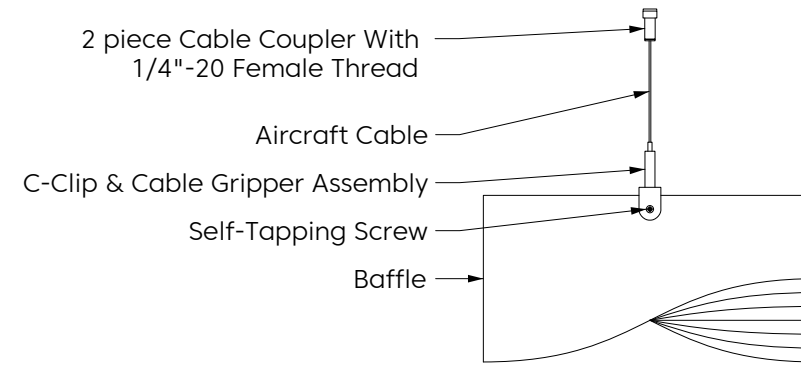

Cable To T Grid

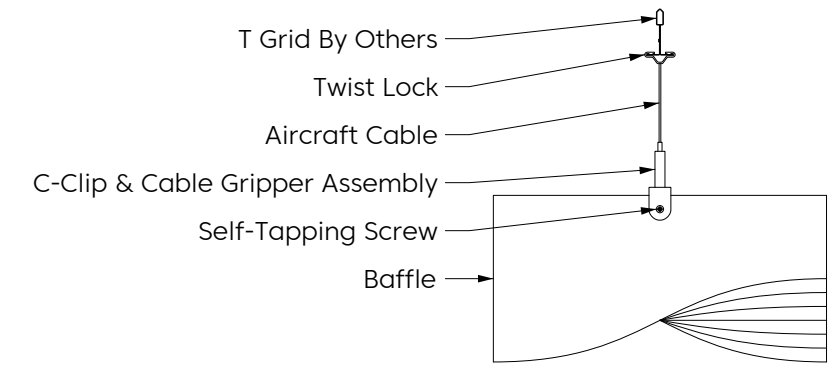

Cable To Unistrut

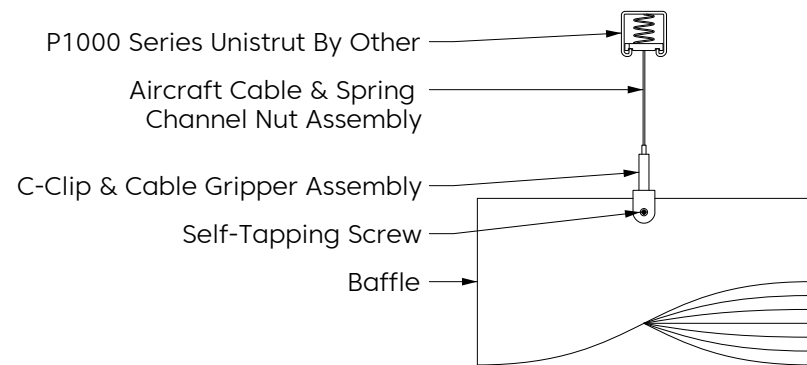

Swivel Cable To Deck

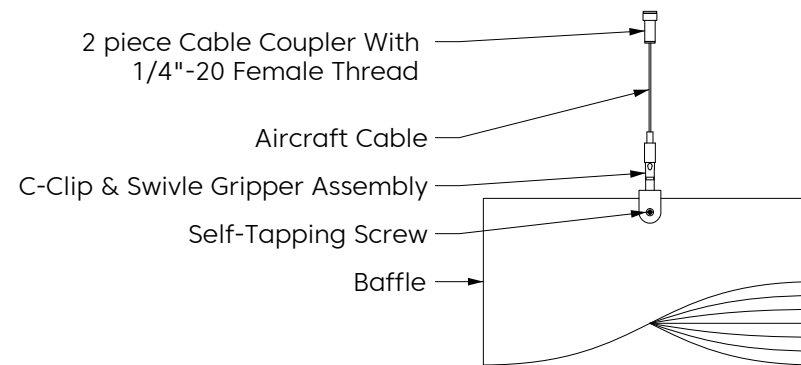

Magnet To T Grid

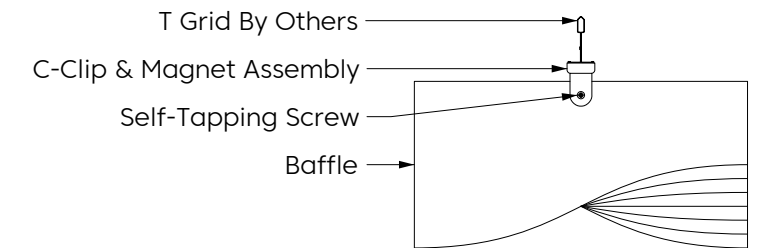

Mounting Methods



Threaded Rod

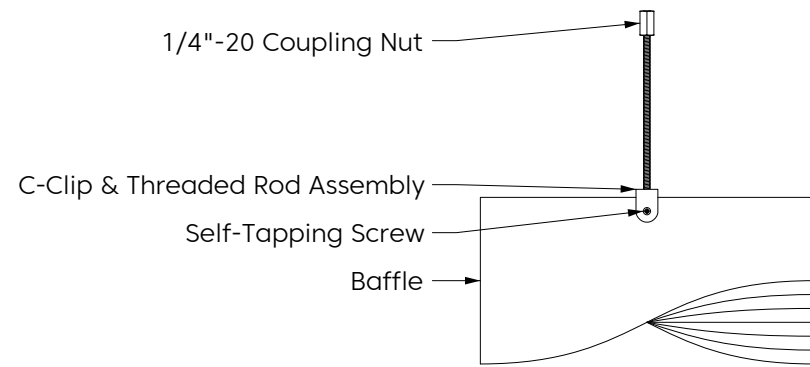

Threaded Rod To Unistrut

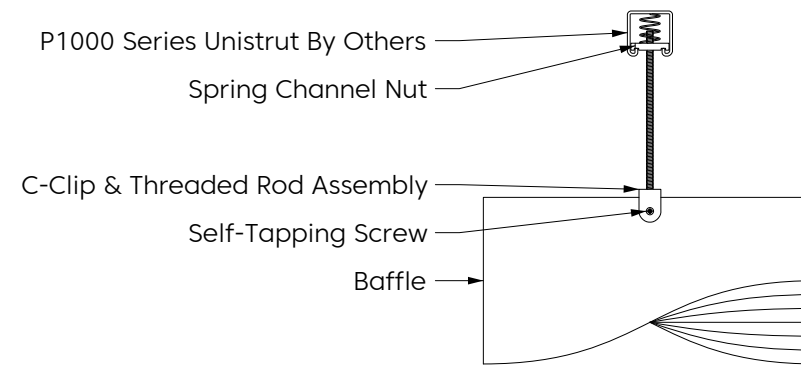

Direct To Unistrut

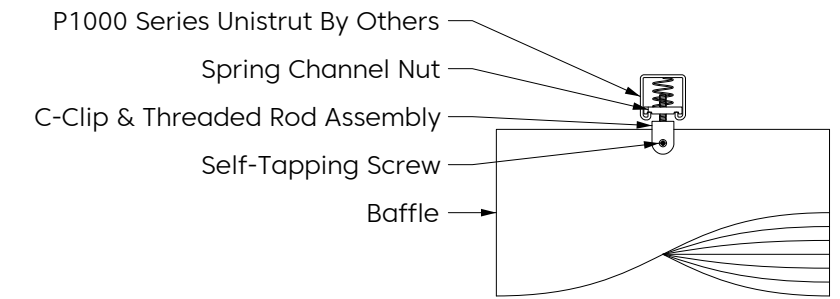

Twist Lock To T Grid

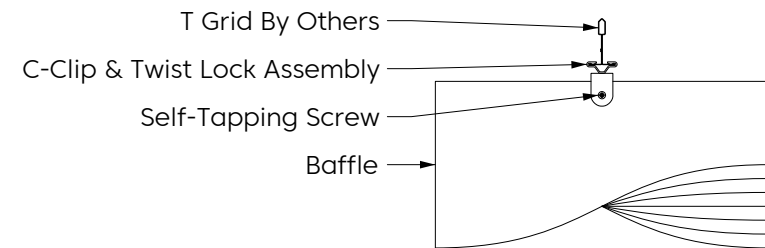

Colorways



Lipstick Red
LI14



Carrot
CA08



Butter
BU07



Popcorn
PO26



Pistachio
PI25



Wasabi
WA29

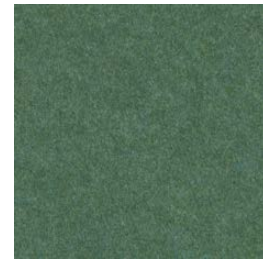

Thistle
TH28

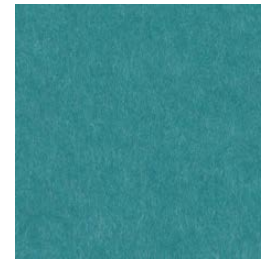

Peacock
PE20

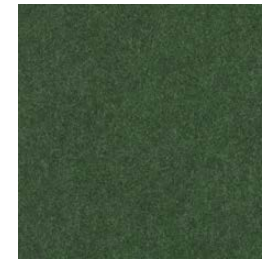

Oregano
OR18



Kale
KA12

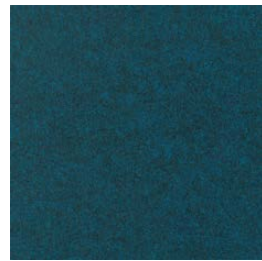

Denim
DE09



Midnight
MI16



Azur
AZ05



Marine
MA15

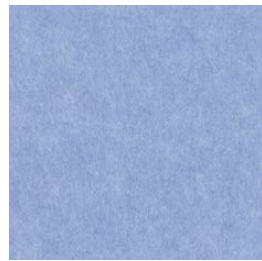

Periwinkle
PE23



Iris
IR10



Berry
BE06



Lilac
LI13



Peach
PE19



Peppercorn
PE22



Piano Black
PI24



Charcoal
CH01

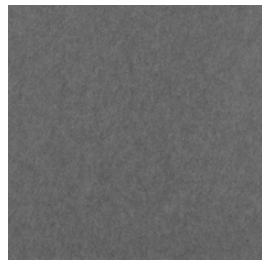

Slate
SL27



Grey
GR02

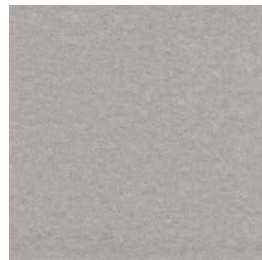

Metal
ME03

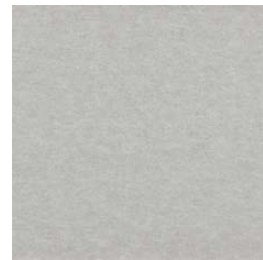

Platinum
PL04



White
WH12



Pearl
PE21



Ivory
IV11