



# Fan Ceiling Baffle

FilaSorb™ 12

acoufelt  
making quiet

# Product Detail

Product	Fan Ceiling Baffle
Surface	Ceiling
Composition	100% Polyester
Material	FilaSorb™
Recycled Content	60% min.
Thickness	12mm   0.47" +/- 10%
Weight	0.49 lb/ft <sup>2</sup> +/- 10%
Length	48" or 60" or 96" or 110"
Depth	4" Min - 8" Max 5" Min - 10" Max 6" Min - 12" Max Custom size available upon request.

# Technical Data

Fire Test Method Number	AS ISO 9705:Group 1 ASTM E84-17a Class A
Indoor Air Quality	Low VOCs emission, formaldehyde and Phenol-free
Light Fastness	ISO 105-B02 1994, 6-7

# Acoustic Performance

Sound Absorption     ASTM C423 with an ASTM E795 type "J" Mounting  
NRC 0.75 (12mm x 8"D with 6"O.C.)

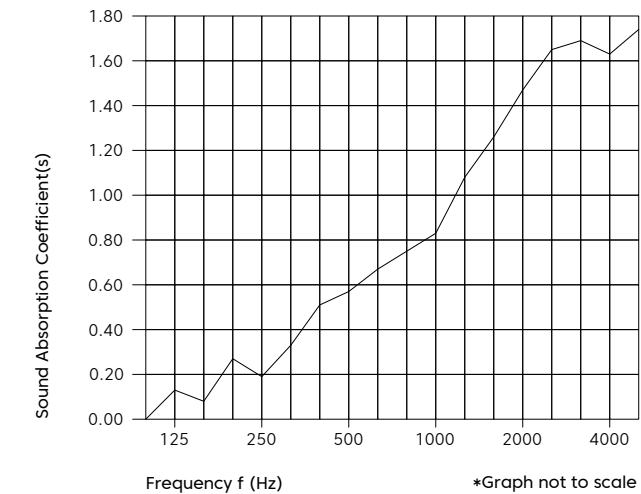

Frequency f (Hz)	125	250	500	1000	2000	4000	NRC
12mm α <sub>s</sub>	0.13	0.19	0.57	0.83	1.47	1.63	0.75
24mm α <sub>s</sub>	Product acoustic performance testing is in progress.						

# Guarantees

Lead Time	Ships in 4-6 weeks
Light Fastness Warranty	10 Years*
Customizable	Yes

\* conditions apply

# Environmental Attributes

- Declare Certification
- LCB Red List Free
- Phenol And Formaldehyde Free
- Low VOC
- CDPH Compliance
- Aligns With Building Standards



# Specifying Process

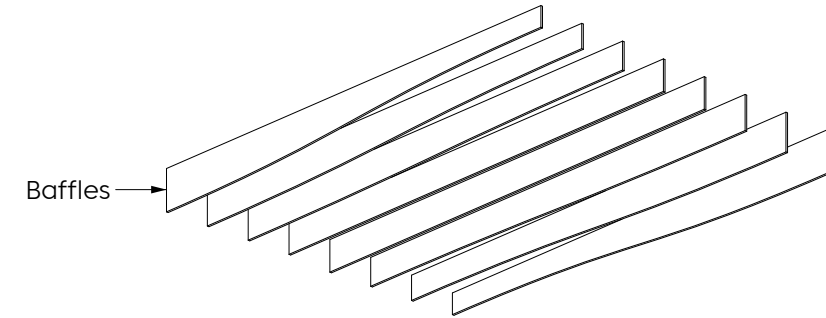
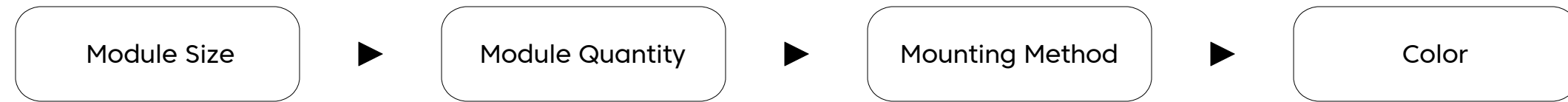

## Choose Your Option See following pages for details.

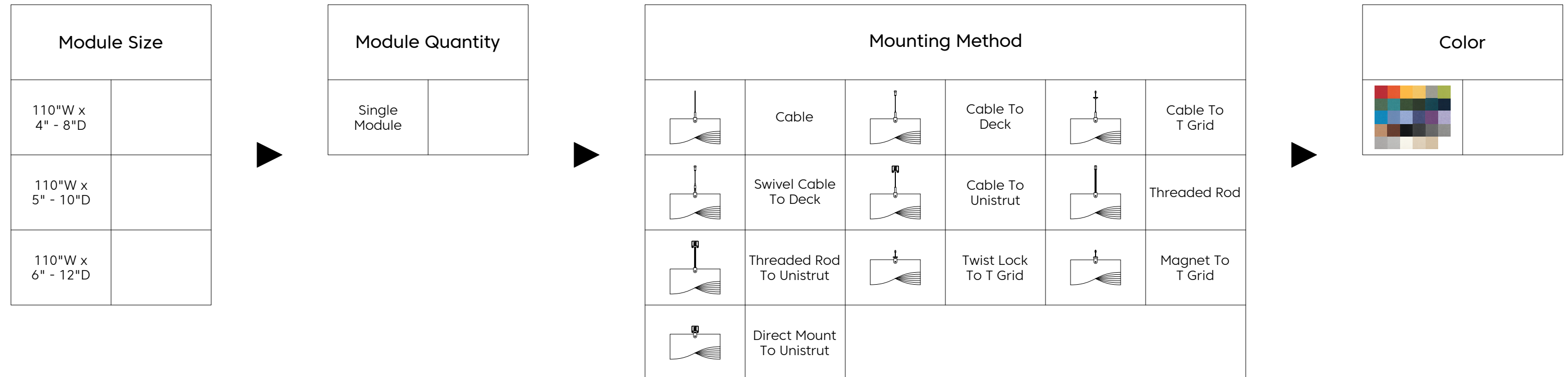

# Design

Elevation

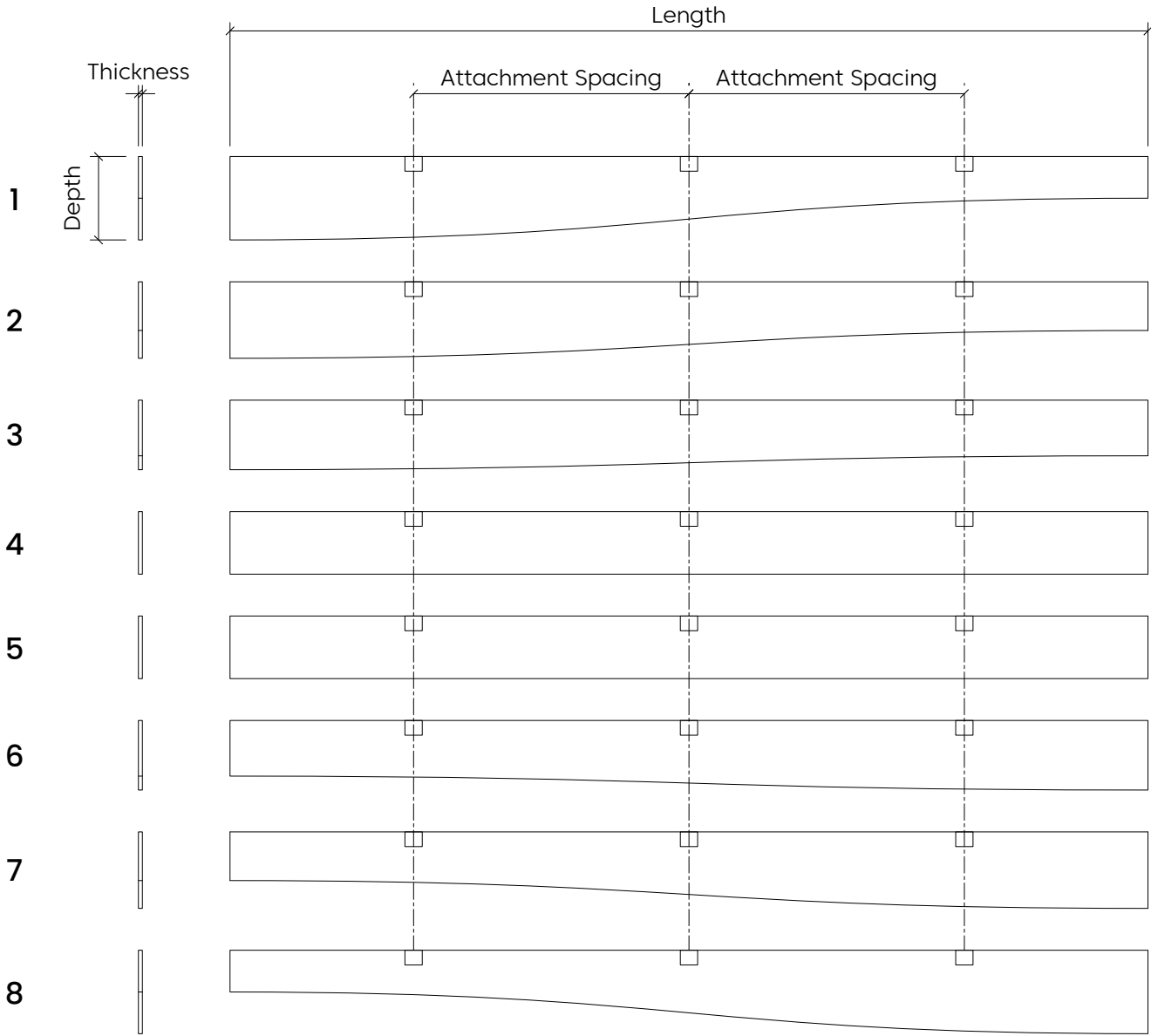

Perspective

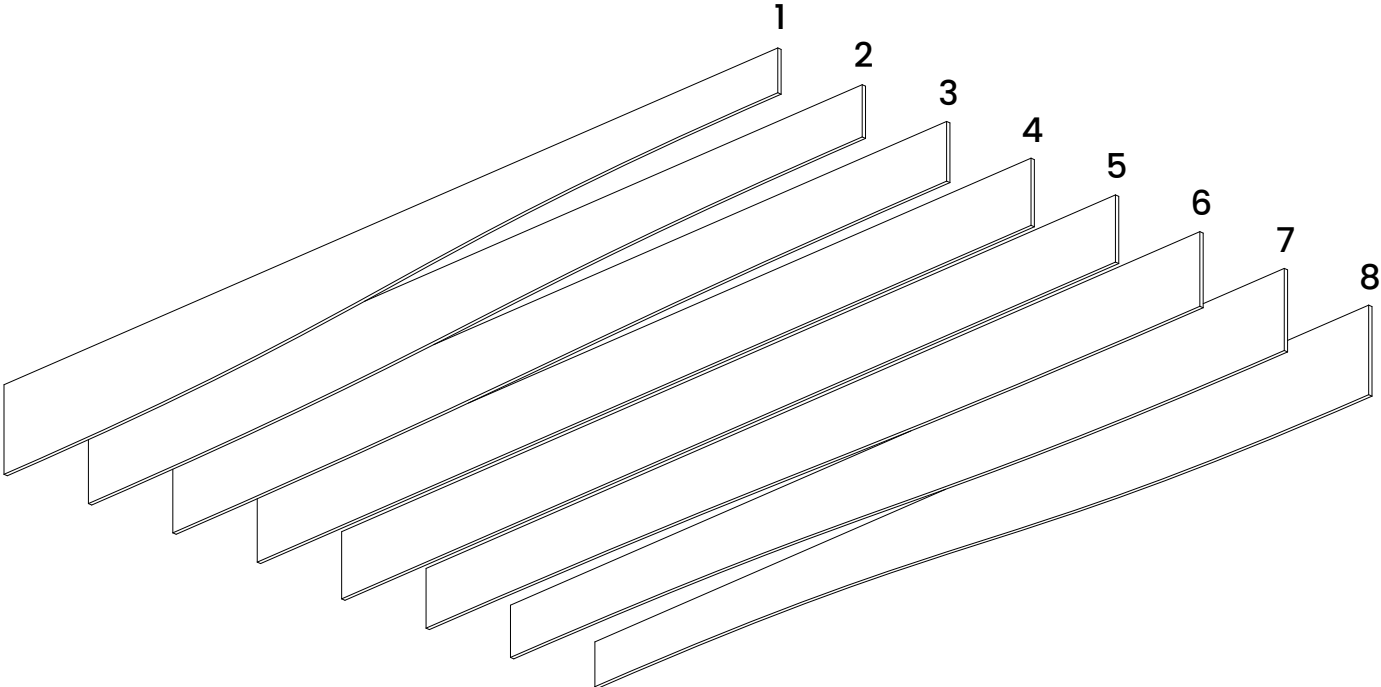

\* Number of connections may vary depending on length

# Design

Module Size



Module Quantity



Mounting Method



Color

Elevation

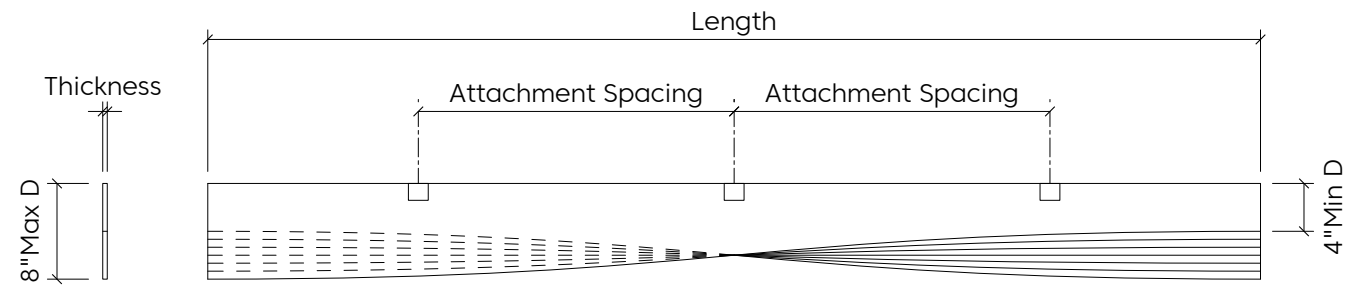

Elevation

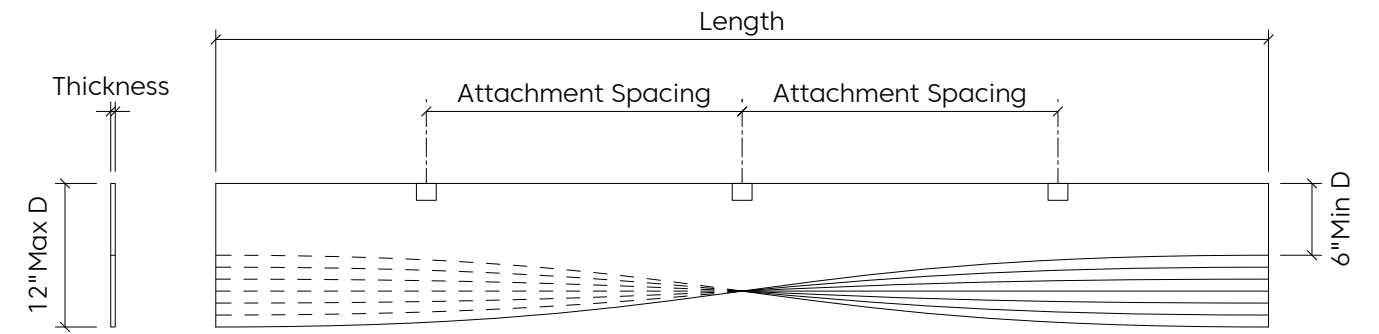

Elevation

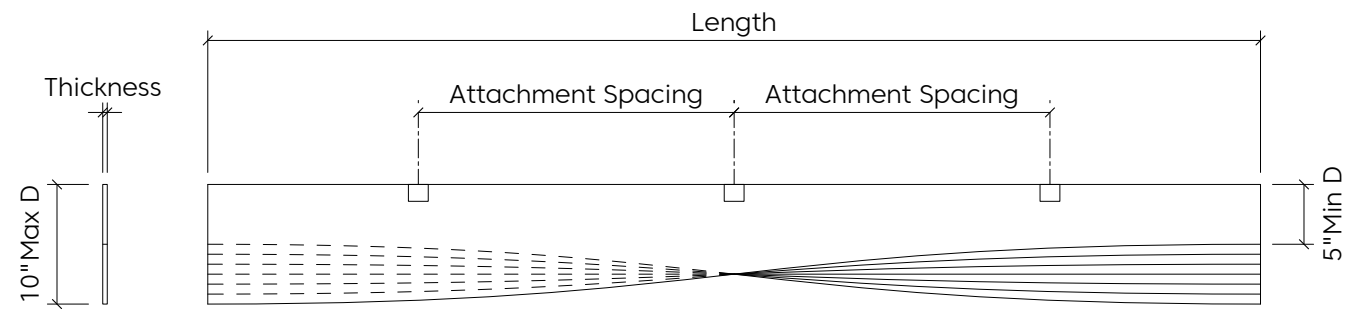

\* Number of connections may vary depending on length

# Single Module



Plan

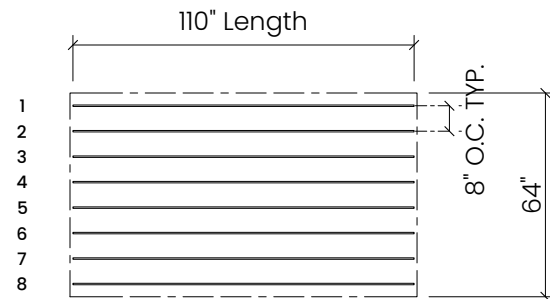

Perspective

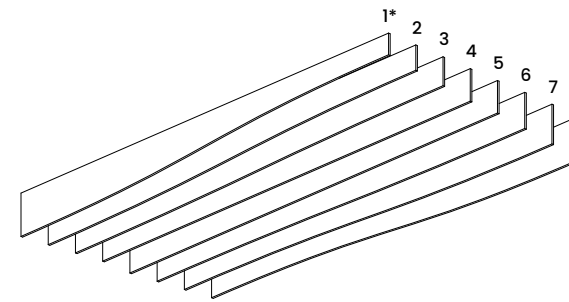

\* Baffle sequence.

# Multiple Modules

Plan

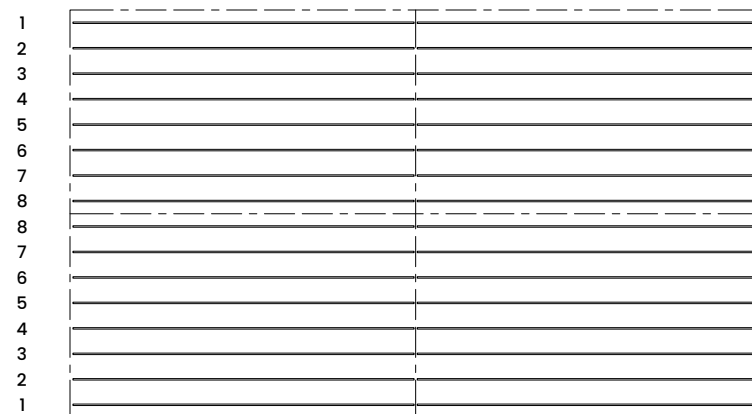

Perspective

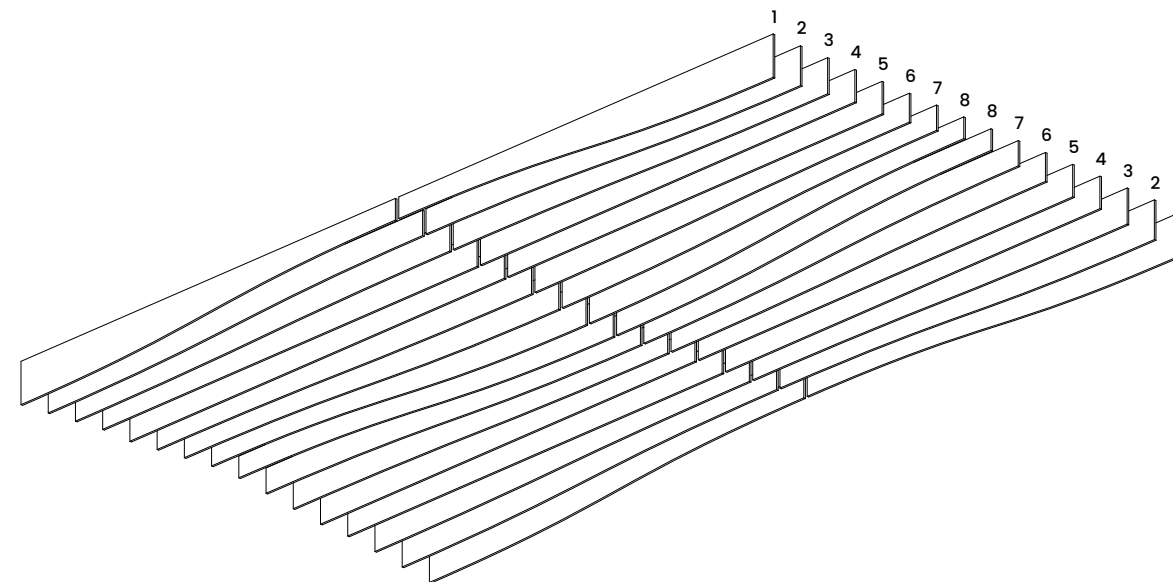

# Layout Guide

Module Size

Module Quantity

Mounting Method

Color

## Standard Layout

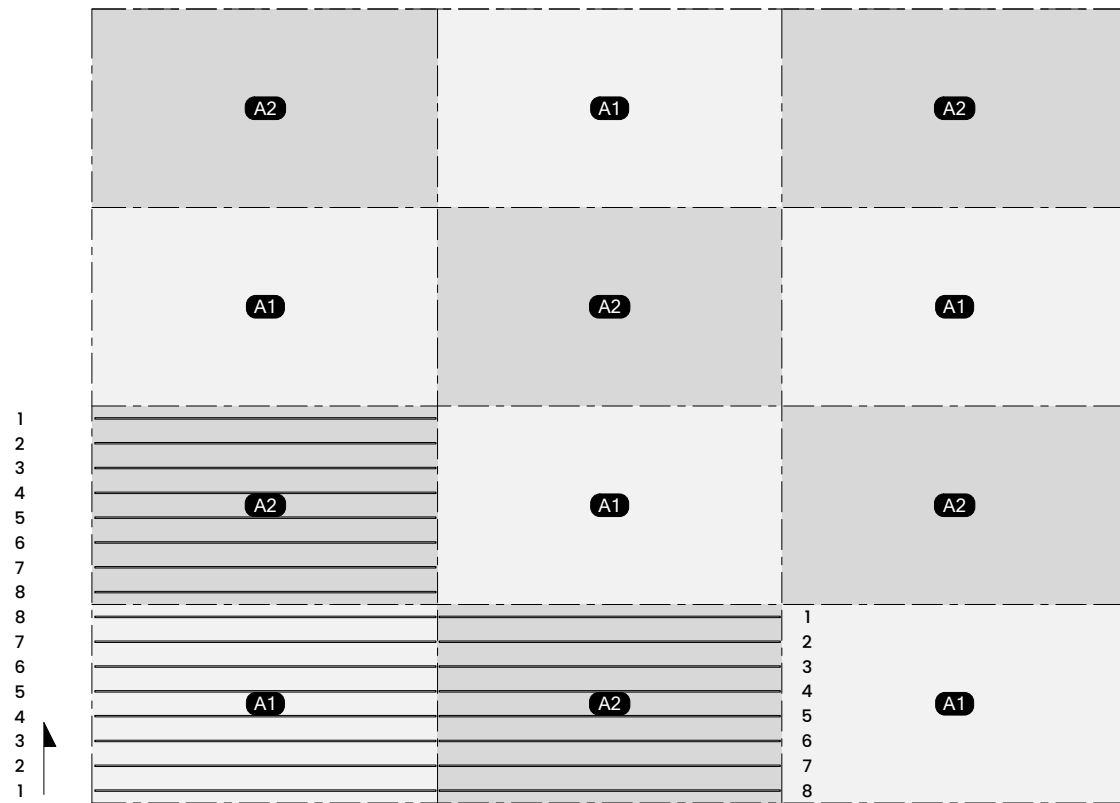

\* Refer to pg.4 for baffle design.

## Module Perspective

Module A1

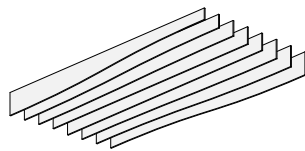

Module A2

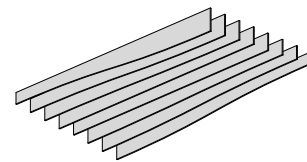

## Perspective

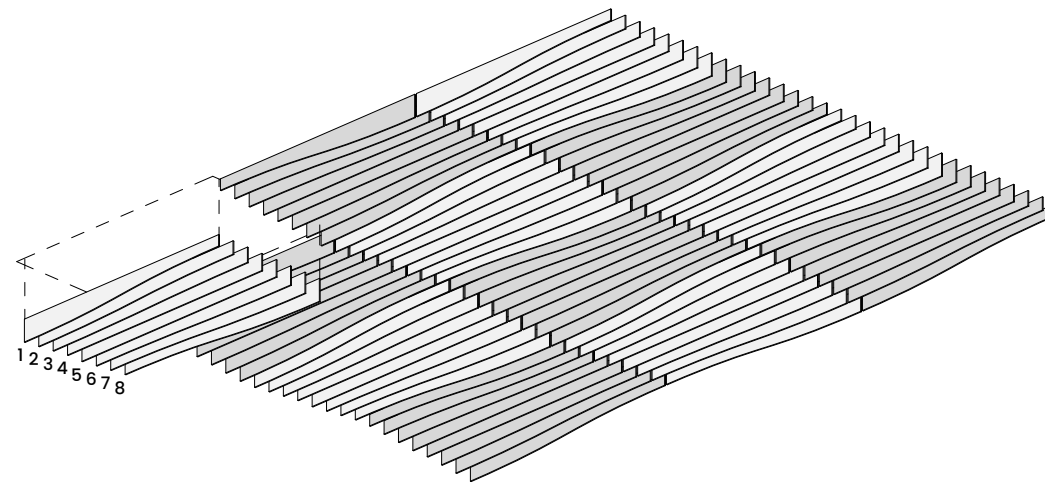

\*Colors shown on this page are for color coding only. Refer to pg. 9 for felt colorways.

## Front Perspective

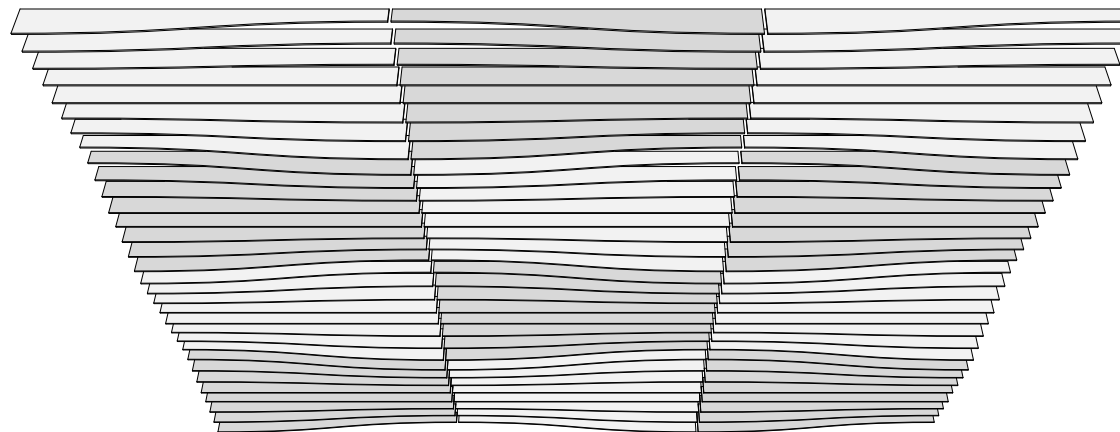

# Mounting Methods

Module Size

Module Quantity

Mounting Method

Color

### Cable

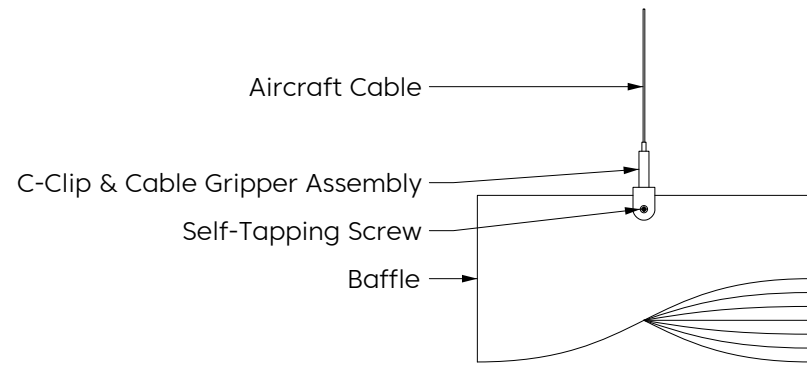

### Cable To Deck

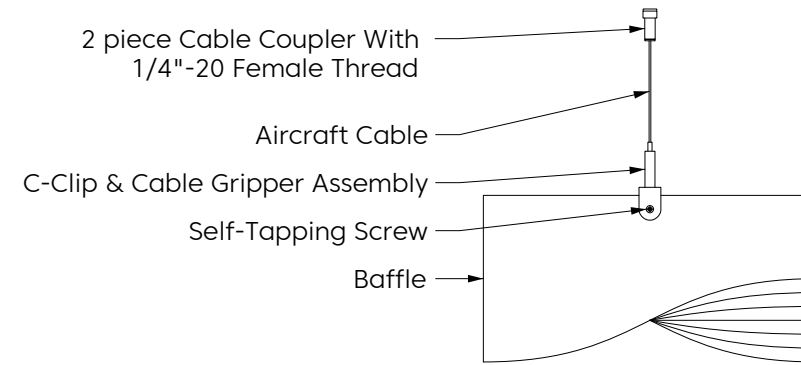

### Cable To T Grid

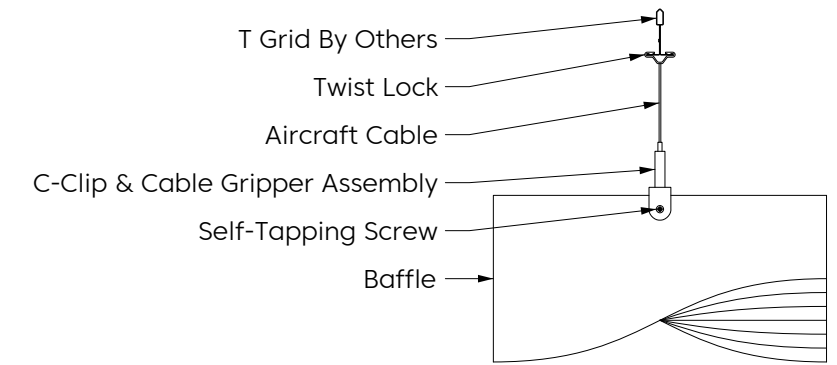

### Cable To Unistrut

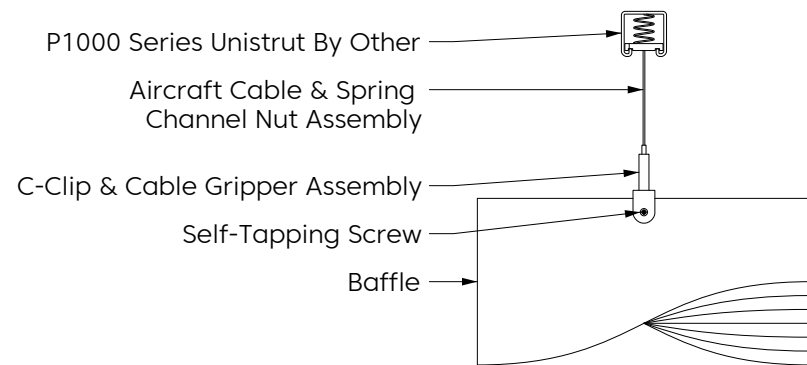

### Swivel Cable To Deck

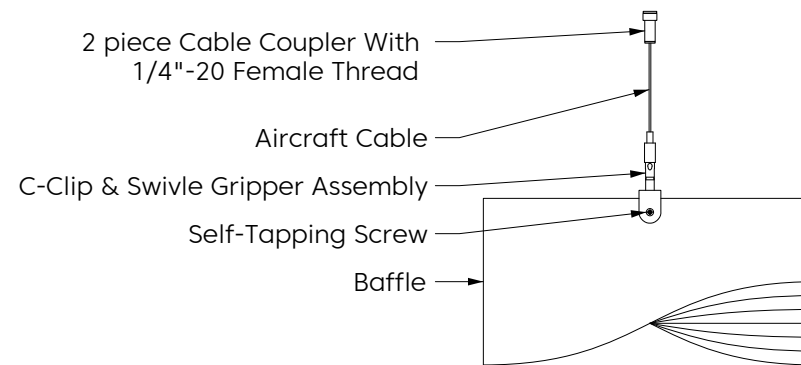

### Magnet To T Grid

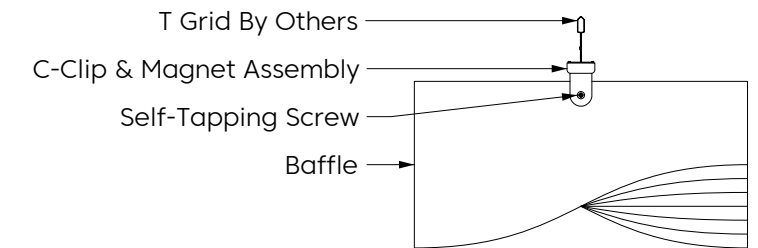



# Mounting Methods



### Threaded Rod

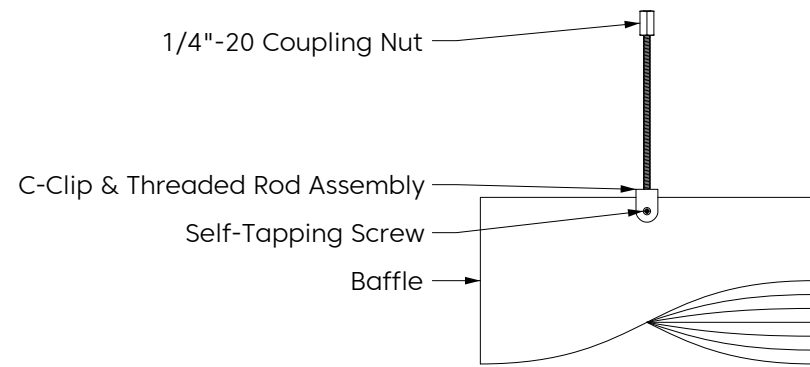

### Threaded Rod To Unistrut

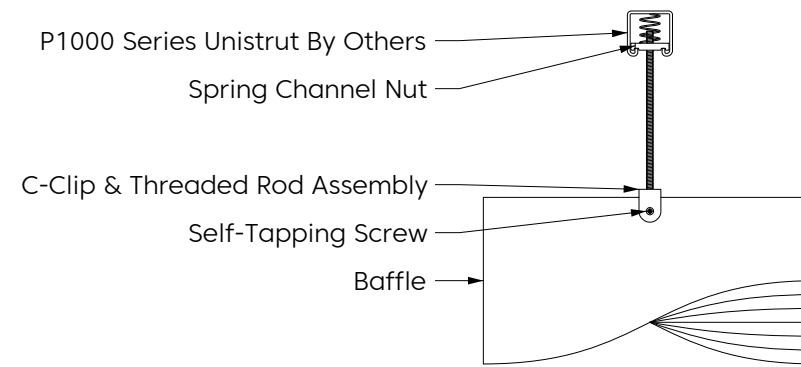

### Direct To Unistrut

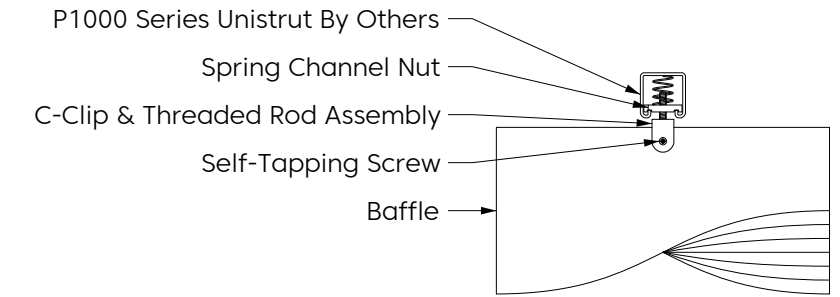

### Twist Lock To T Grid

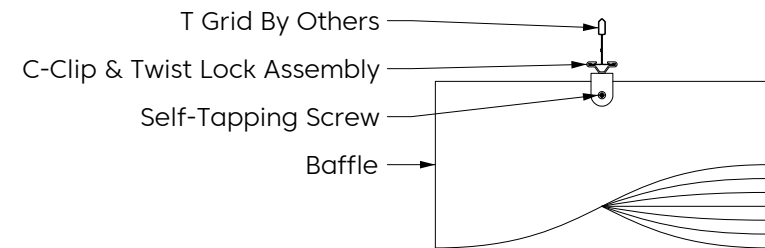

# Colorways

Module Size

Module Quantity

Mounting Method

Color



Lipstick Red  
LI14



Carrot  
CA08

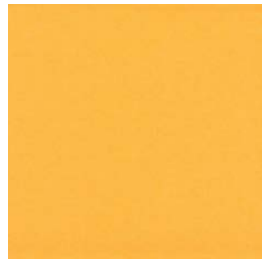

Butter  
BU07



Popcorn  
PO26



Pistachio  
PI25

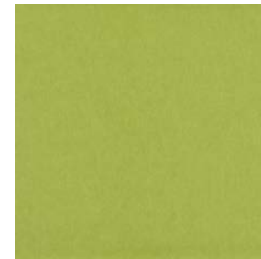

Wasabi  
WA29



Thistle  
TH28

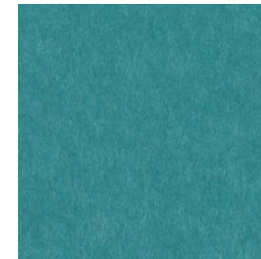

Peacock  
PE20



Oregano  
OR18



Kale  
KA12



Denim  
DE09



Midnight  
MI16



Azur  
AZ05



Marine  
MA15



Periwinkle  
PE23



Iris  
IR10



Berry  
BE06



Lilac  
LI13

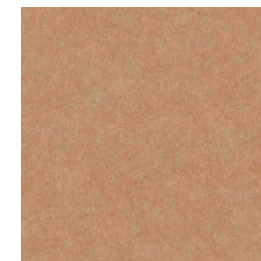

Peach  
PE19



Peppercorn  
PE22



Piano Black  
PI24



Charcoal  
CH01

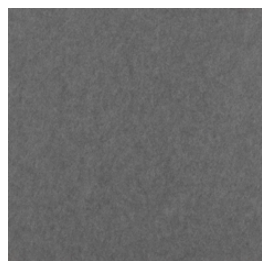

Slate  
SL27



Grey  
GR02

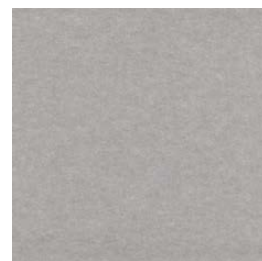

Metal  
ME03



Platinum  
PL04



White  
WH12



Pearl  
PE21



Ivory  
IV11