

Shapes Wall Tiles

Premier Collection

Soundscaping your space with acoustic wall tiles lets you play with color, tone, and patterns while building felt wall mosaics. Make your own designs from our collection of geometric and organic shapes offered in our broad color palette.

Specifications

Surface	Wall
Material	FilaSorb™ polyester felt
Thickness	1/2", 12mm (±10%) 1", 24mm (±10%)
Weight	12mm, 0.49 lb./ft ² (±10%) 24mm, 0.98 lb./ft ² (±10%)
Standard Sizes	6, 9, 10.39, 12, 15.59, 16, 18, 20.78, 24, 32" W 6, 9, 12, 16, 18, 24" H <i>Sizes based on shape</i>



Hexagon in Grey, Metal, Platinum and White

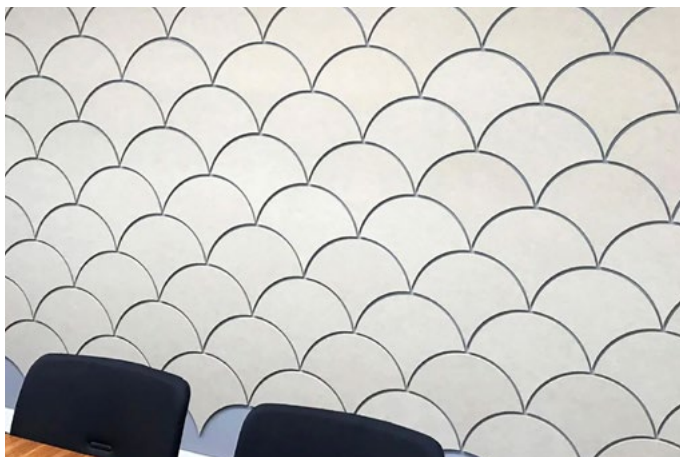

Scale in Platinum

Technical

NRC Rating	12mm, 0.45 24mm, 0.60
Fire Test	ASTM E84, Class A Flame spread index: 15 Smoke developed index: 200
Water Sorption	ASTM C1104-2019 (A Modified) Water sorbed by weight: 0.20% (based on a 12mm thick panel)
Colorfastness	ISO 105-B02, 6-7

Details

Lead Time	3 – 6 weeks
Origin	Manufactured and assembled in the US
Warranty	Product: 20 years* Colorfastness: 20 years*

* Conditions apply

Environmental

Recycled Content	Minimum 60%
Energy	Generated using 40% solar energy
Indoor Air Quality	VOC less than/equal to 0.5mg/m3
Recyclable	100%*
Certifications	Health Product Declaration (HPD)** Environmental Product Declaration Declare Certification - LBC Red List Free (third-party verified) SCS Global Indoor Advantage Gold

* PET is recyclable through participating partners.

** HPD only applies to 12mm thickness.



© The Health Product Declaration® logo is a registered trademark of HPD Collaborative.



Call **800.966.8557** with questions or visit **acoufelt.com** for more product information, downloads, and colorways.

Colorways

PREMIER



White
WH12

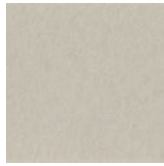

Almond
AL55



Celery
CE65



Sencha
SE58



Metal
ME03



Flamingo
FL61

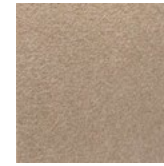

Quartz
QU67

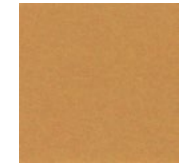

Turmeric
TU60

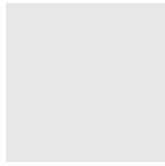

Platinum
PL04



Pearl
PE21



Pistachio
PI25

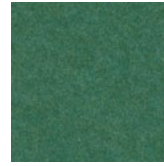

Thistle
TH28

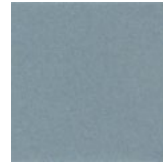

Stonewash
ST72

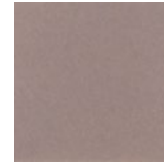

Amethyst
AM69



Valentine
VA70

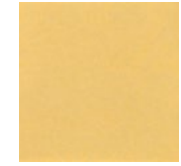

Wheat
WH68

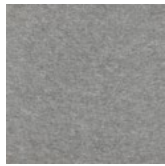

Grey
GR02



Ivory
IV11

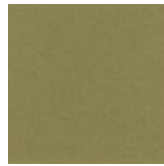

Eucalyptus
EU71



Peacock
PE20



Periwinkle
PE23



Lilac
LI13



Peach
PE19



Popcorn
PO26



Slate
SL27

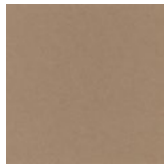

Umber
UM54

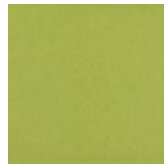

Wasabi
WA29



Sea Salt
SE57

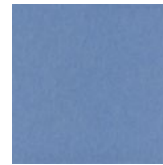

Marine
MA15



Berry
BE06

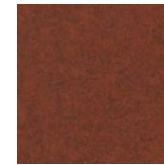

Peppercorn
PE22



Carrot
CA08

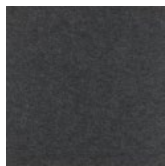

Charcoal
CH01

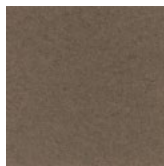

Walnut
WA56

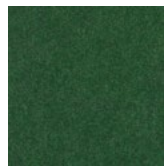

Oregano
OR18

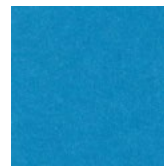

Azure
AZ05

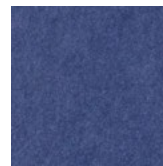

Iris
IR10

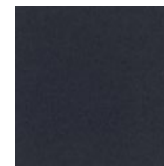

Flint
FL64

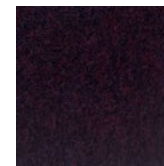

Shiraz
SH63

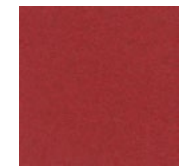

Currant
CU59

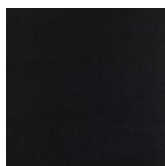

Piano Black
PI24

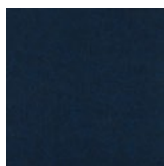

Midnight
MI16

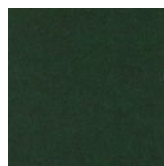

Kale
KA12

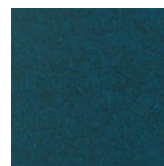

Denim
DE09

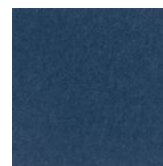

Granite
GR62

Order samples at acoufelt.com/colorways



Call 800.966.8557 with questions or visit acoufelt.com for more product information, downloads, and colorways.

Sizes

Standard Heights 6, 9, 10.39, 12, 15.59, 16, 18, 20.78, 24, 32" W
Sizes based on shape. See below.

Thickness 1/2", 12mm ($\pm 10\%$)
 1", 14mm ($\pm 10\%$)

Standard Widths 6, 9, 12, 16, 18, 24" H
Sizes based on shape. See below.

Circle

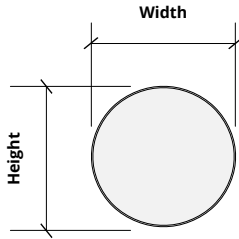

Small 12" W x 12" H
Medium 18" W x 18" H
Large 24" W x 24" H

Diamond

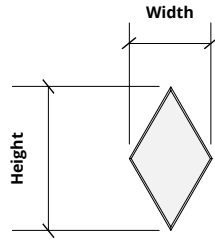

Small 6" W x 10.39" H
Medium 9" W x 15.59" H
Large 12" W x 20.78" H

Hexagon

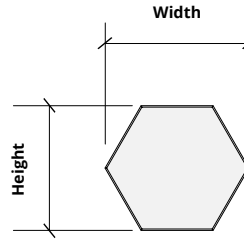

Small 12" W x 10.39" H
Medium 18" W x 15.59" H
Large 24" W x 20.78" H

Ogee

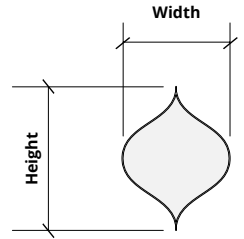

Small 12" W x 16" H
Medium 18" W x 24" H
Large 24" W x 32" H

Rectangle

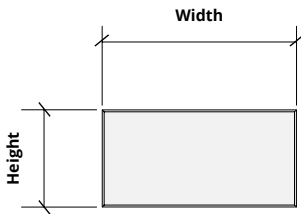

Small 12" W x 6" H
Medium 18" W x 9" H
Large 24" W x 12" H

Right Triangle

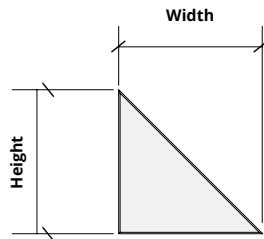

Small 12" W x 12" H
Medium 18" W x 18" H
Large 24" W x 24" H

Scale

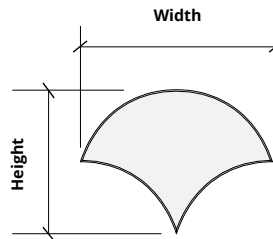

Small 16" W x 12" H
Medium 24" W x 18" H
Large 32" W x 24" H

Square

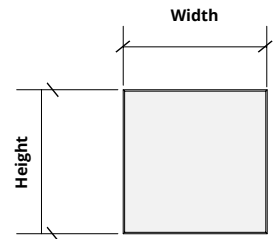

Small 12" W x 12" H
Medium 18" W x 18" H
Large 24" W x 24" H

12mm
thickness



24mm
thickness



Mounting Methods

Adhesive backing

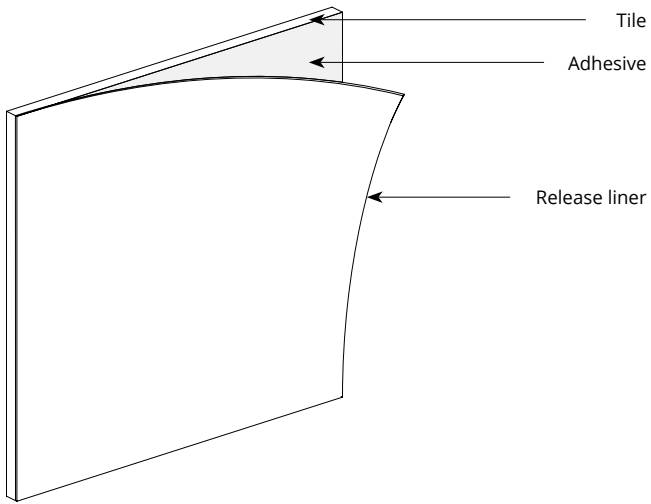

Construction adhesive

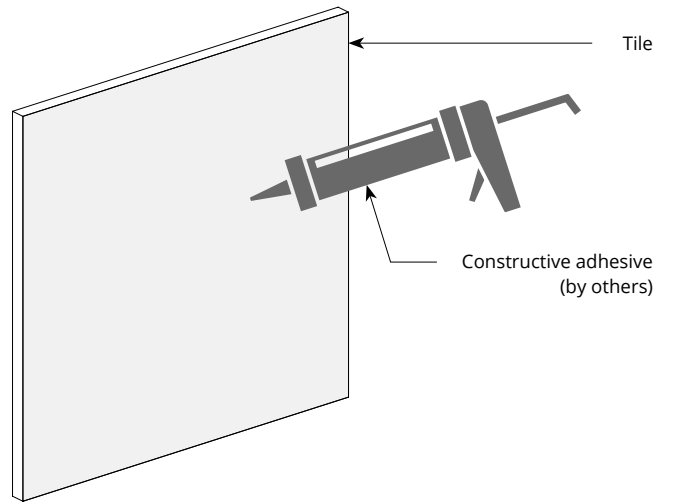

Acoustic Performance

Test Method	ISO 354-2006
Install Method	Type A
Mounting Method	No air gap
Rating Method	ISO 11654-1997
Test Results	<p>12mm</p> <p>NRC 0.45</p> <p>SAA 0.43</p> <p>24mm</p> <p>NRC 0.60</p> <p>SAA 0.55</p>

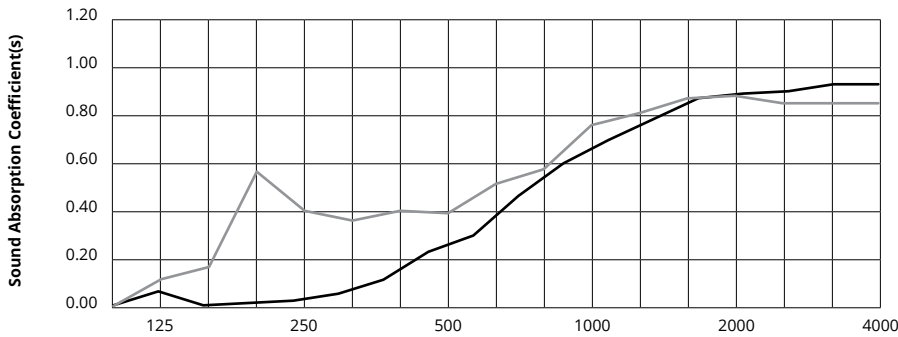

	Frequency f (Hz)	125	250	500	1000	2000	4000	NRC
	12mm	0.06	0.02	0.23	0.61	0.89	0.95	0.45
	24mm	0.02	0.57	0.41	0.58	0.87	0.85	0.60

What is a Noise Reduction Coefficient (NRC)?

You'll find the NRC rating in the specifications of all of our products. This acronym stands for Noise Reduction Coefficient, and is expressed as a single number, a rating that describes the degree to which acoustic products can absorb sound.

You can use NRC values to understand the overall performance of our acoustic wall and ceiling products. The higher the NRC, the better the product is at soaking up the sound.

Performance Indices: Noise Reduction Coefficient (NRC) results represent the absorption coefficients measured at the one third octave bands at 125, 250, 500, 1000, 2000 and 4000 Hz rounded to the nearest 0.05. Acoustic testing has been performed according to the methods mentioned above. Customization of installation of the product could alter the results. Sound Absorption Average (SAA) indicates the absorption coefficient average for the twelve one-third octave bands ranging between 200 and 2500 Hz.