



Fracture Wall Panels

Premier Collection

Fracture panels are an acoustic wall treatment precision carved with a beveled groove into a series of directional linework designs. Install these panels together to create spectacular, full-scale patterns of rich color, depth, shadow, and texture.

Specifications

Surface	Wall
Material	FilaSorb™ polyester felt
Thickness	1/2", 12mm (±10%) 1", 24mm (±10%)
Weight	12mm, 0.49 lb./ft ² (±10%) 24mm, 0.98 lb./ft ² (±10%)
Standard Sizes	48" W x 108" H <i>Custom sizes available</i>

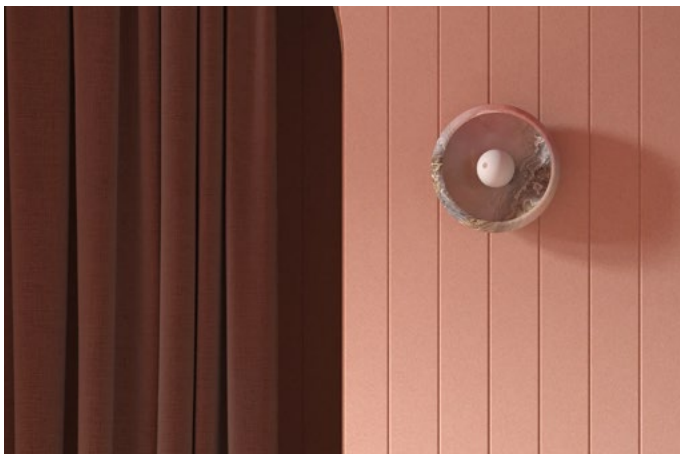

Fracture Wall Panel with Finline Pattern in Flamingo

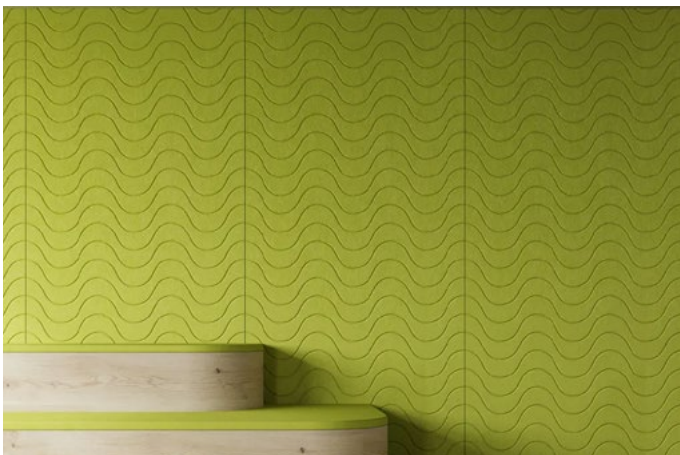

Fracture Wall Panel with Wavelength Pattern in Wasabi

Technical

NRC Rating	12mm 0.45, no air gap 0.54, 12mm air gap 0.64, 20mm air gap 24mm 0.60, no air gap
Fire Test	ASTM E84, Class A Flame spread index: 15 Smoke developed index: 200
Water Sorption	ASTM C1104-2019 (A Modified) Water sorbed by weight: 0.20% (based on a 12mm thick panel)
Colorfastness	ISO 105-B02, 6-7

Details

Lead Time	3 – 6 weeks
Origin	Manufactured and assembled in the US
Warranty	Product: 20 years* Colorfastness: 20 years*

* Conditions apply

Environmental

Recycled Content	Minimum 60%
Energy	Generated using 40% solar energy
Indoor Air Quality	VOC less than/equal to 0.5mg/m3
Recyclable	100%*
Certifications	Health Product Declaration (HPD)** Environmental Product Declaration Declare Certification - LBC Red List Free (third-party verified) SCS Global Indoor Advantage Gold

* PET is recyclable through participating partners.

** HPD only applies to 12mm thickness.

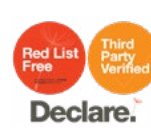

© The Health Product Declaration® logo is a registered trademark of HPD Collaborative.



Call **800.966.8557** with questions or visit **acoufelt.com** for more product information, downloads, and colorways.

Colorways

PREMIER

							
White WH12	Almond AL55	Celery CE65	Sencha SE58	Metal ME03	Flamingo FL61	Quartz QU67	Turmeric TU60
							
Platinum PL04	Pearl PE21	Pistachio PI25	Thistle TH28	Stonewash ST72	Amethyst AM69	Valentine VA70	Wheat WH68
							
Grey GR02	Ivory IV11	Eucalyptus EU71	Peacock PE20	Periwinkle PE23	Lilac LI13	Peach PE19	Popcorn PO26
							
Slate SL27	Umber UM54	Wasabi WA29	Sea Salt SE57	Marine MA15	Berry BE06	Peppercorn PE22	Carrot CA08
							
Charcoal CH01	Walnut WA56	Oregano OR18	Azure AZ05	Iris IR10	Flint FL64	Shiraz SH63	Currant CU59
							
Piano Black PI24	Midnight MI16	Kale KA12	Denim DE09	Granite GR62			

Order samples at acoufelt.com/colorways



Call 800.966.8557 with questions or visit acoufelt.com for more product information, downloads, and colorways.

Sizes

Standard Sizes	48" W x 108" H <i>Custom sizes available</i>
Thickness	1/2", 12mm (±10%) 1", 24mm (±10%)

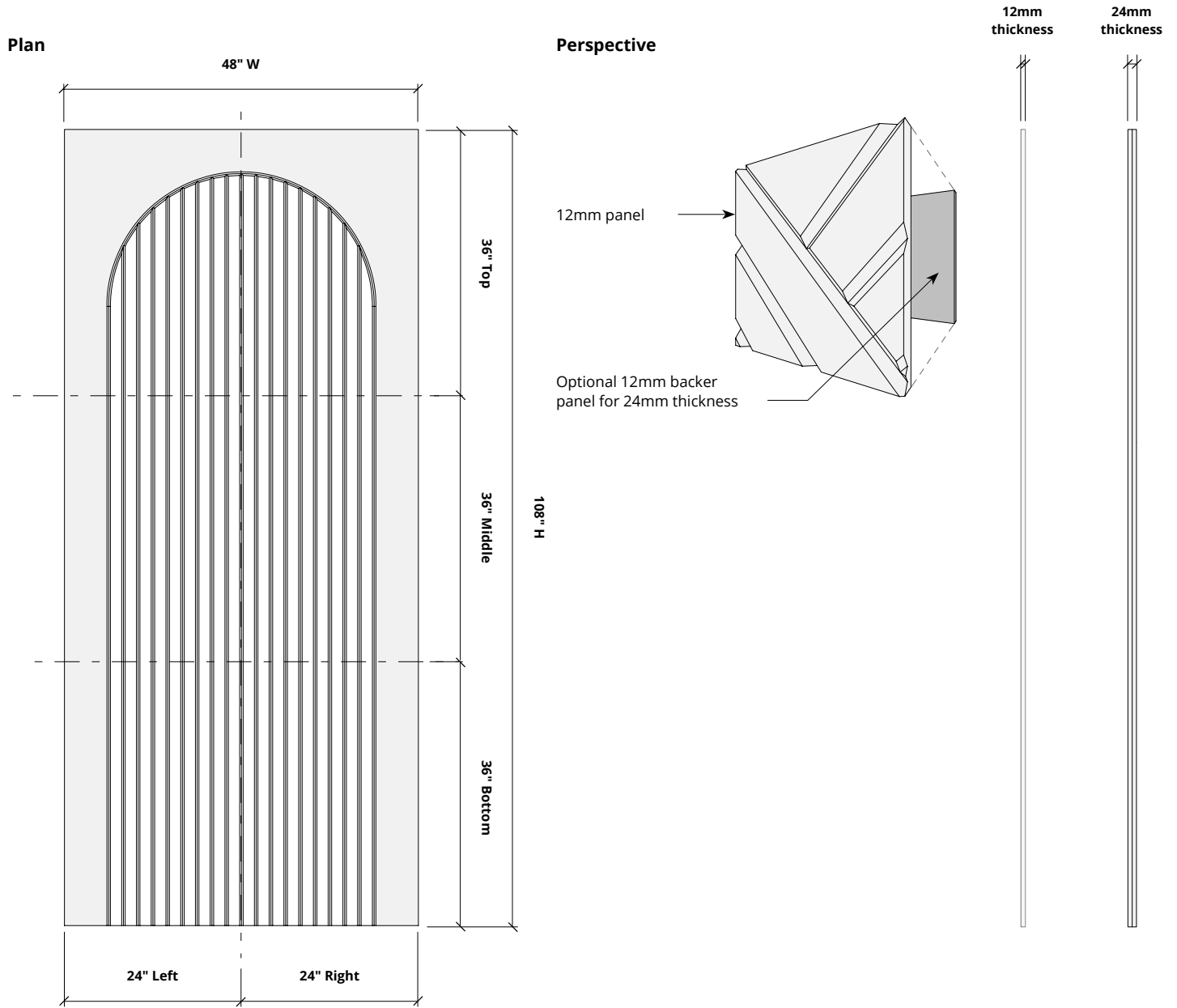

* Product available as full panels or as sections of a panel as filler pieces.
Choose any of the standard height or segments (i.e. bottom right, middle left, etc) to fill the space as needed.

How to Specify

1. Choose Panel Pattern

2. Choose Colorways

Select desired panel pattern. See recommended layouts for larger designs.

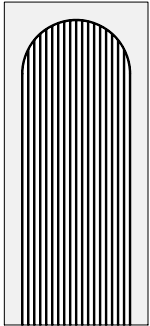

ARCH



CHEVRON

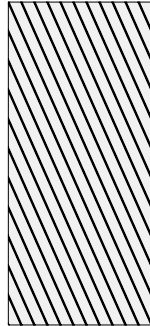

DIAGONAL

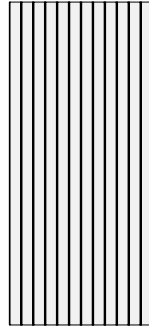

FINELINE

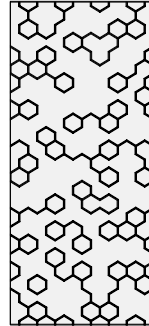

FORMULA

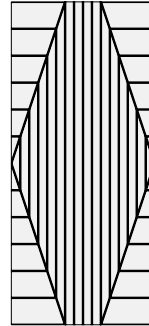

HARLEQUIN

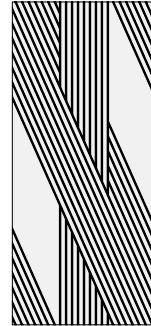

INTERSECT



KNIT

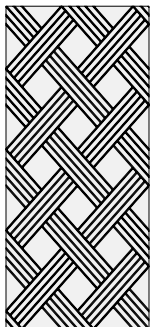

LATTICE

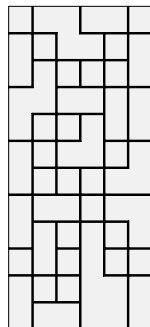

MAZE

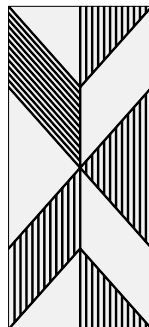

METROPOLIS

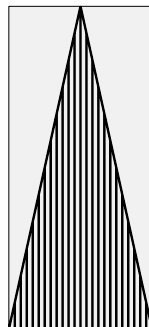

PENNANT

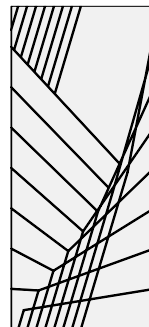

PRISM

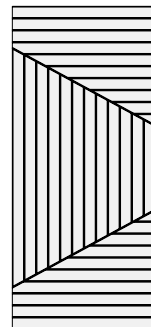

PULSE

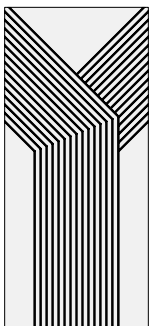

ROWHOUSE

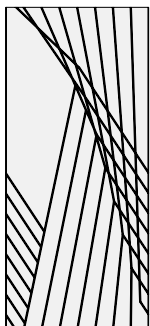

SPIROGRAPH

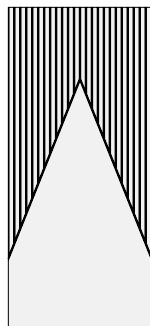

SUMMIT

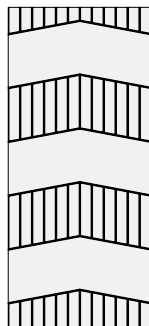

TRACK

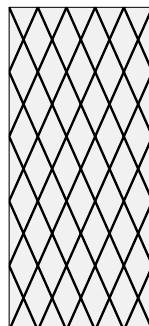

TRELLIS

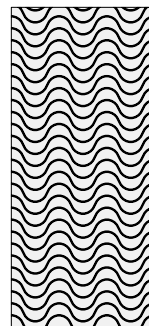

WAVELENGTH

1. Choose Panel Pattern

2. Choose Colorways

See colorways on page 3.



Call **800.966.8557** with questions or visit **acoufelt.com** for more product information, downloads, and colorways.

Recommended Layouts

Arch

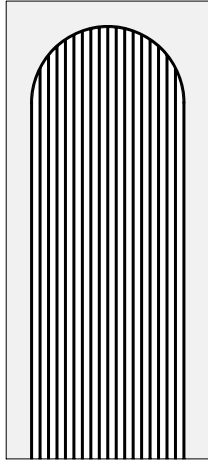

Layout 1

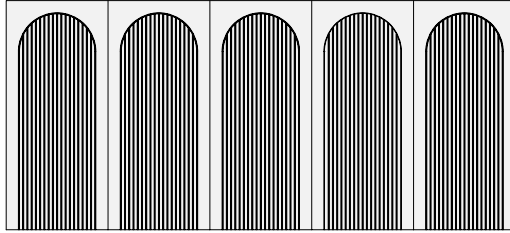

Layout 2

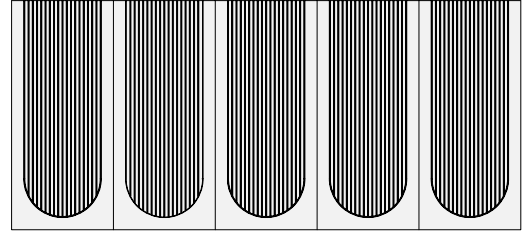

Layout 3

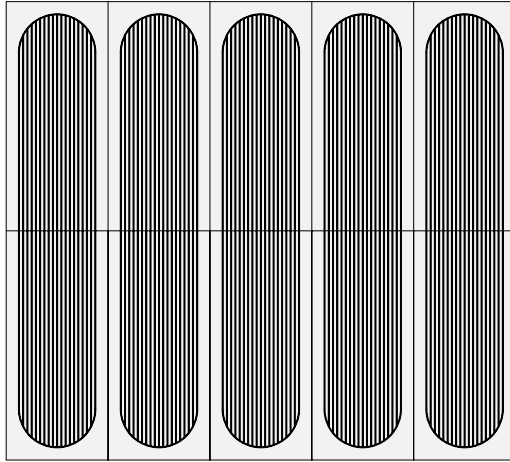

Layout 4

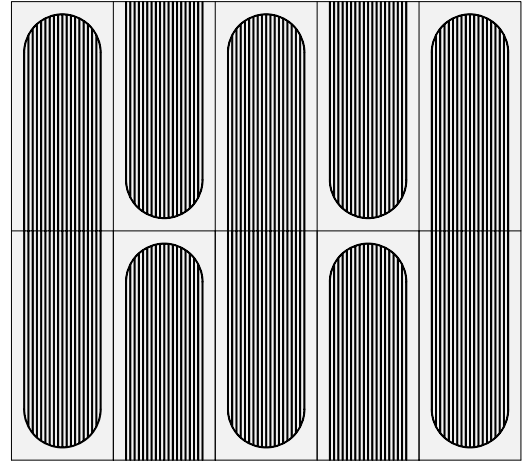

Recommended Layouts

Chevron



Layout 1

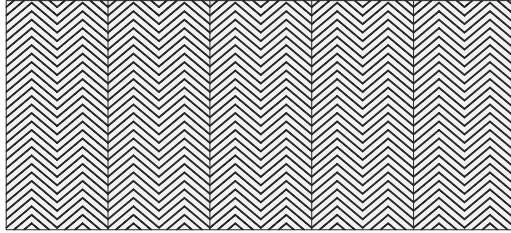

Layout 2

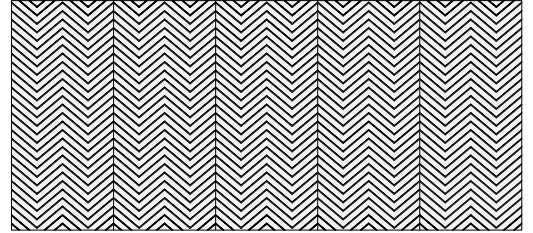

Layout 3

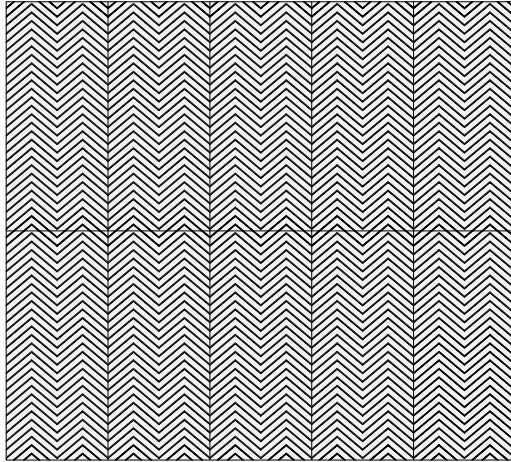

Layout 4

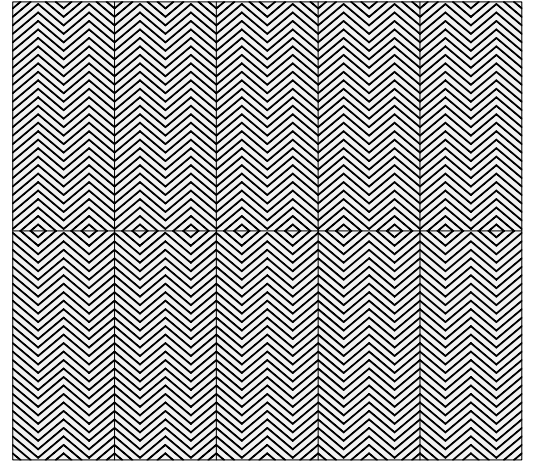

Recommended Layouts

Diagonal

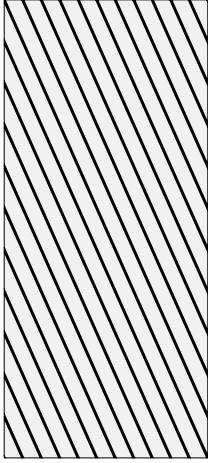

Layout 1

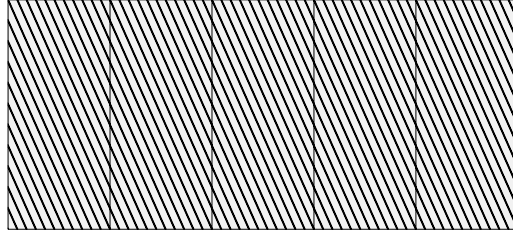

Layout 2

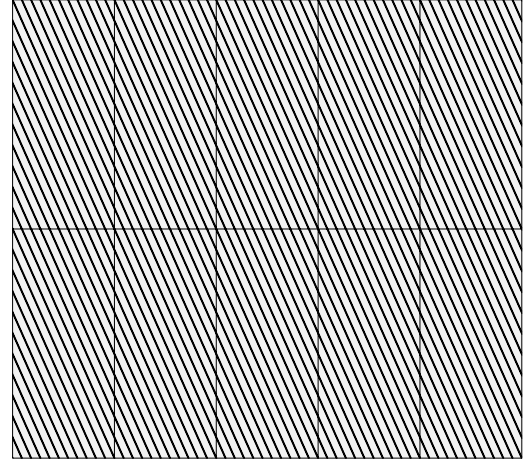

Recommended Layouts

Fineline

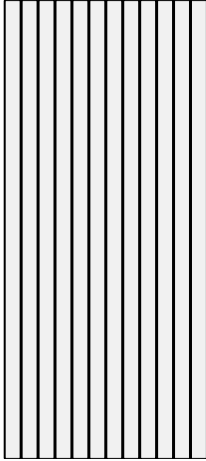

Layout 1

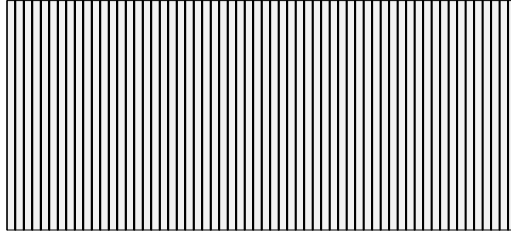

Layout 2

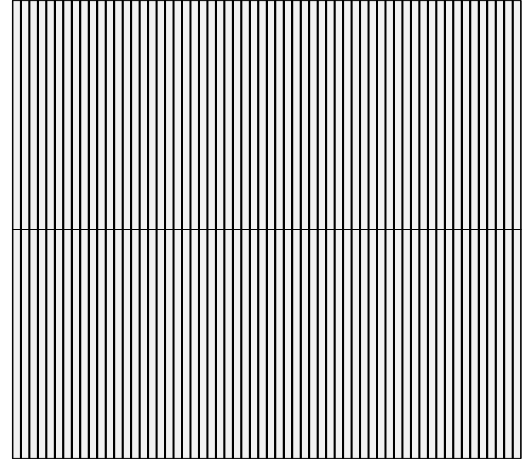

Recommended Layouts

Formula

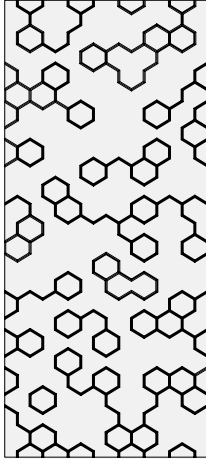

Layout 1

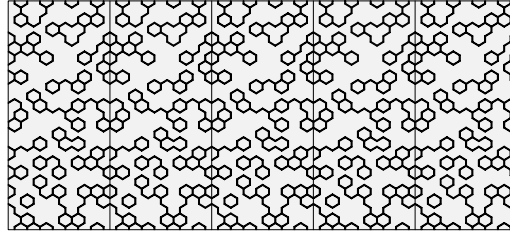

Layout 2

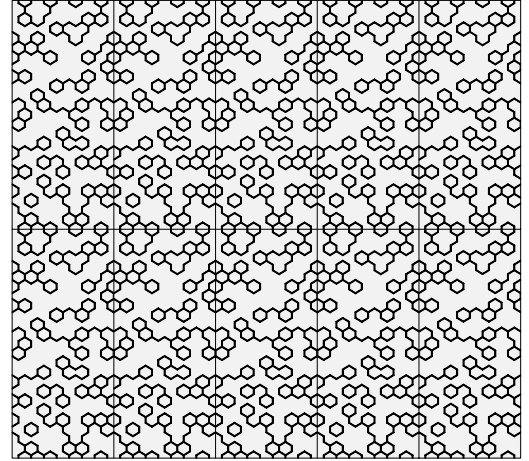

Recommended Layouts

Harlequin

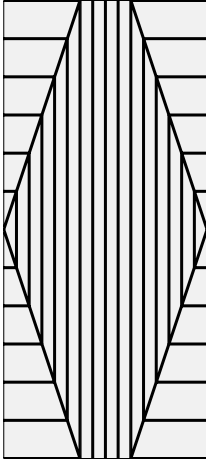

Layout 1

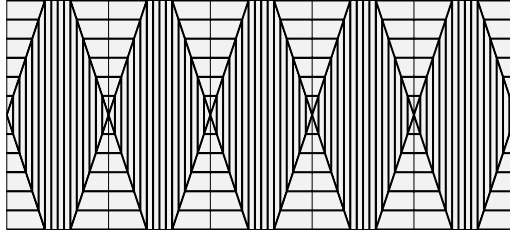

Layout 2

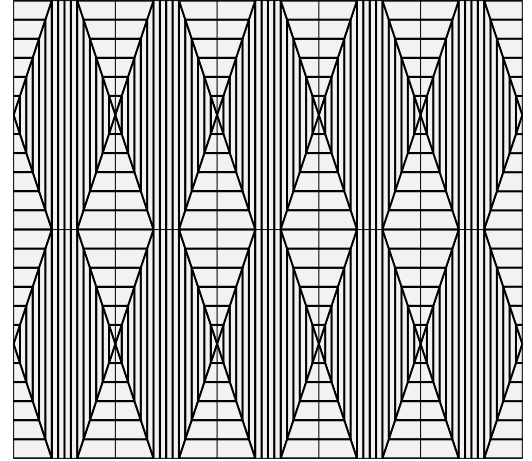

Recommended Layouts

Intersect

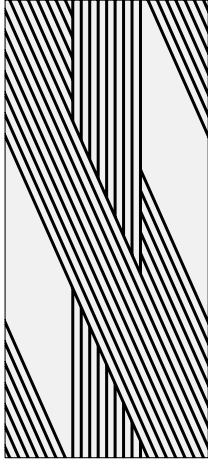

Layout 1

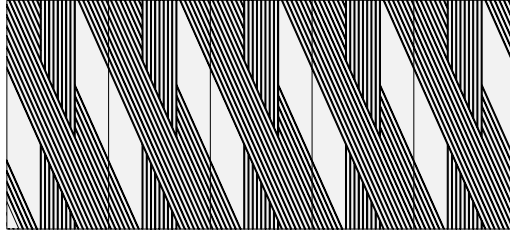

Layout 2

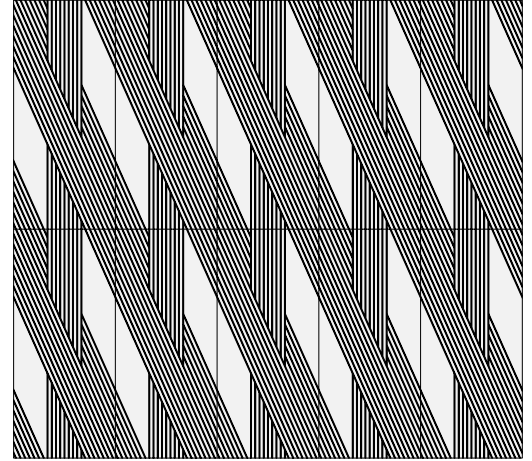

Recommended Layouts

Knit

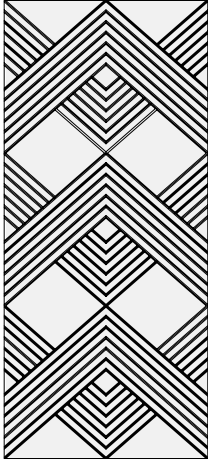

Layout 1

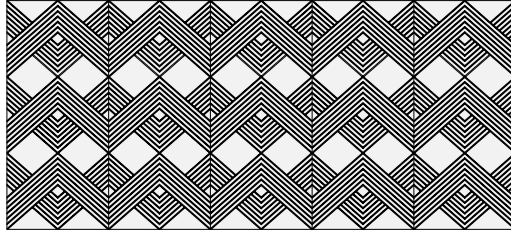

Layout 2

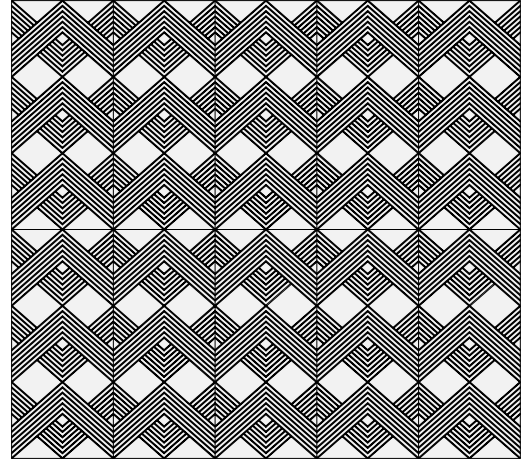

Recommended Layouts

Lattice

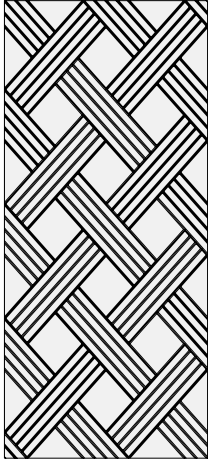

Layout 1

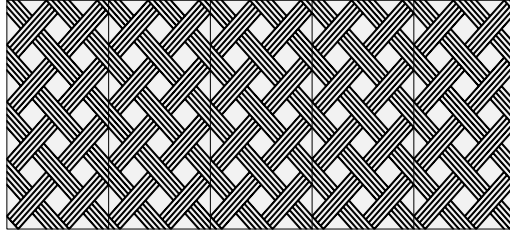

Layout 2

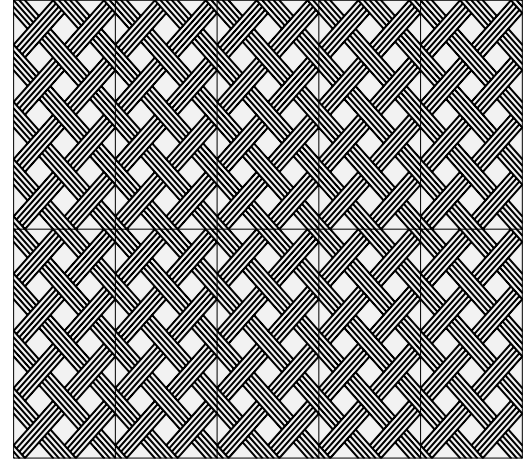

Recommended Layouts

Maze

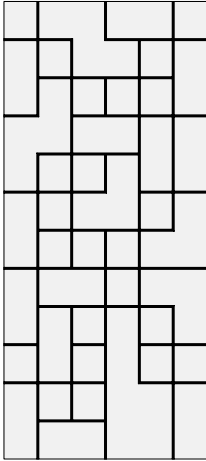

Layout 1

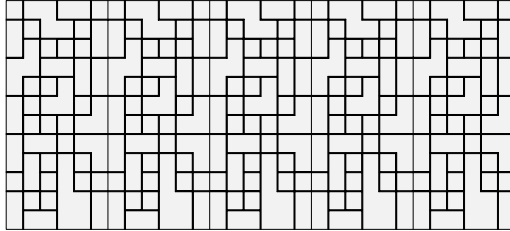

Layout 2

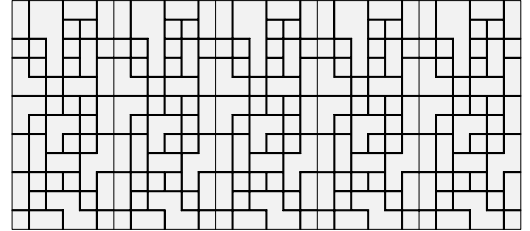

Layout 3

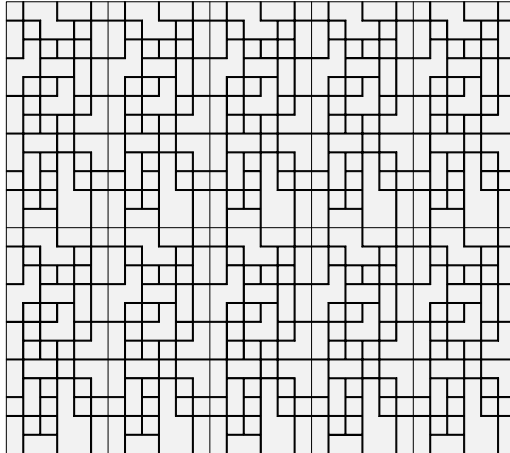

Layout 4

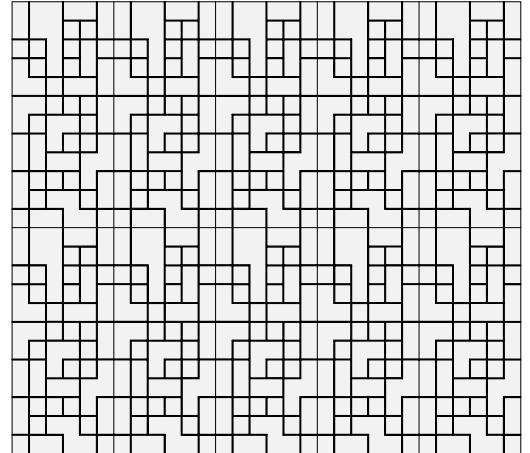

Recommended Layouts

Metropolis

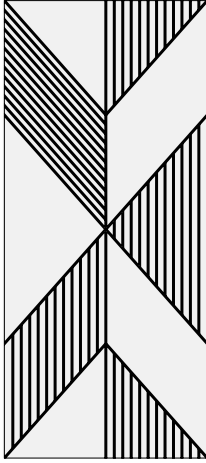

Layout 1

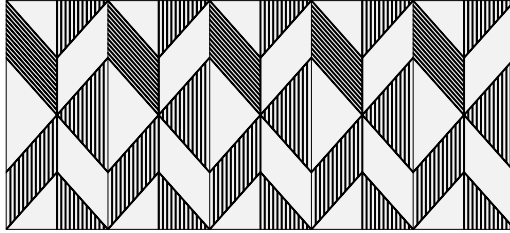

Layout 2

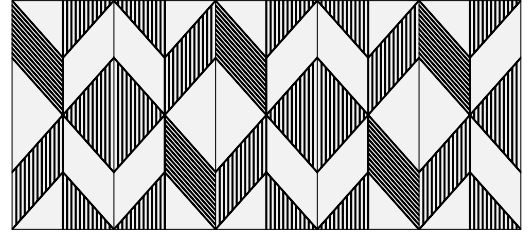

Layout 3

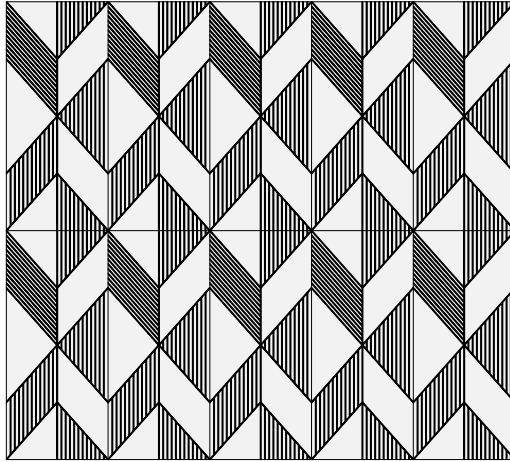

Layout 4

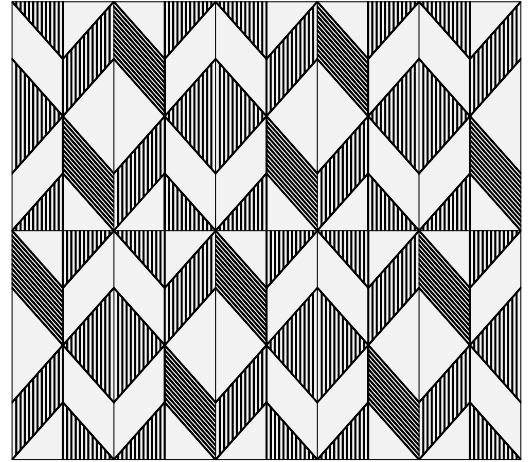

Recommended Layouts

Pennant

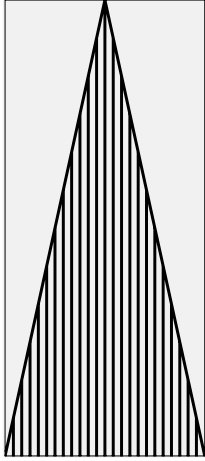

Layout 1

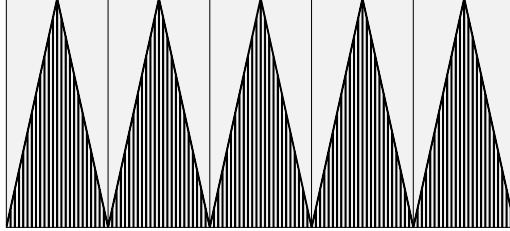

Layout 2

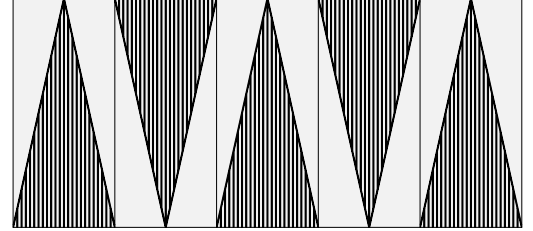

Layout 3

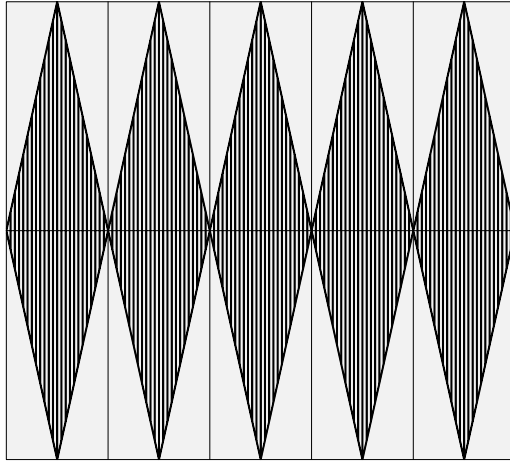

Layout 4

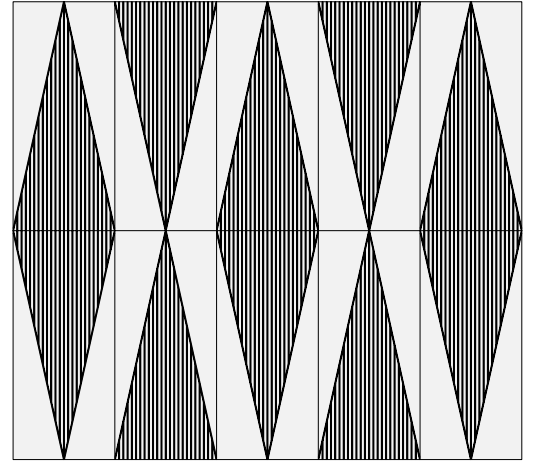

Recommended Layouts

Prism

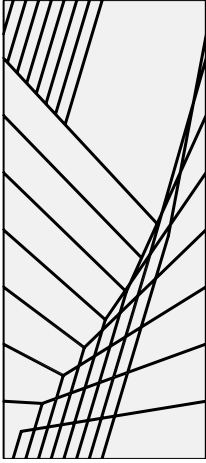

Layout 1

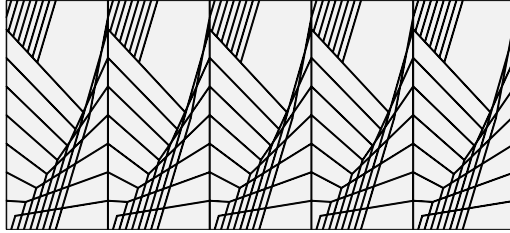

Layout 2

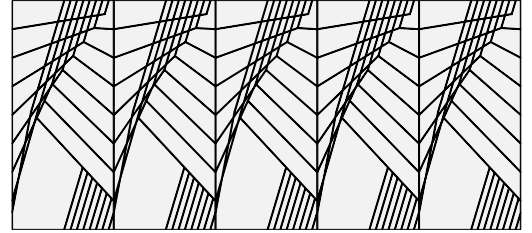

Layout 3

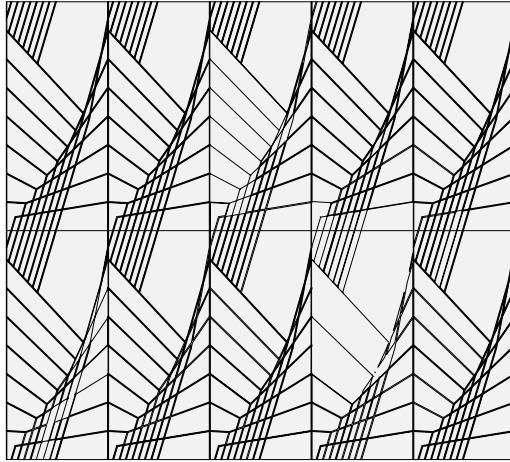

Layout 4

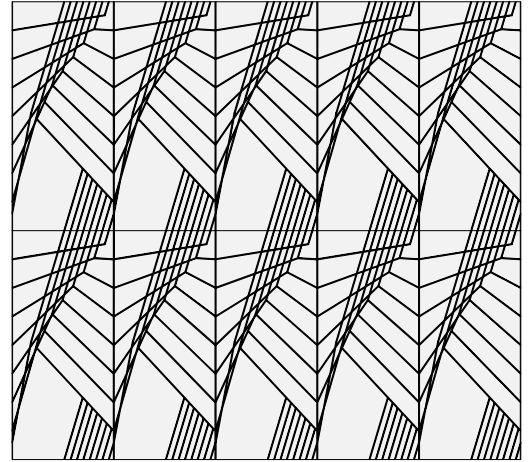

Recommended Layouts

Pulse

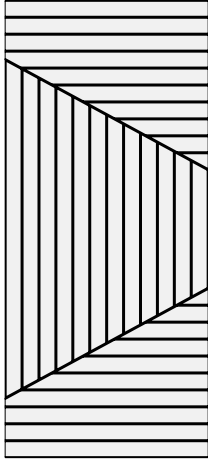

Layout 1

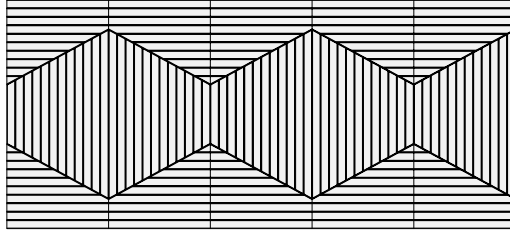

Layout 2

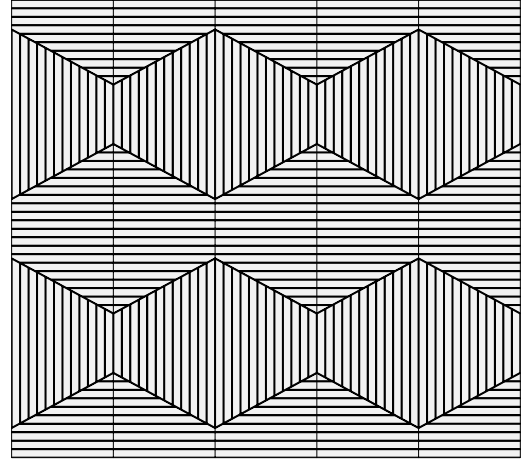

Recommended Layouts

Rowhouse

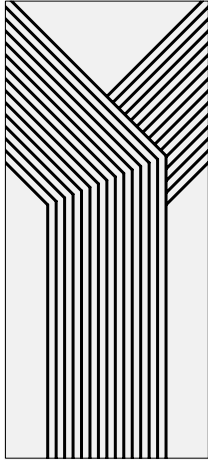

Layout 1

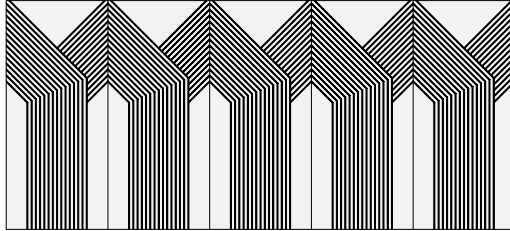

Layout 2

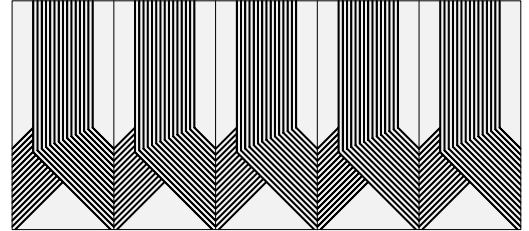

Layout 3

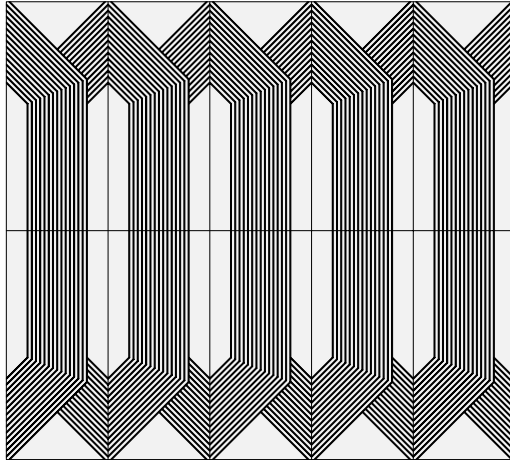

Layout 4

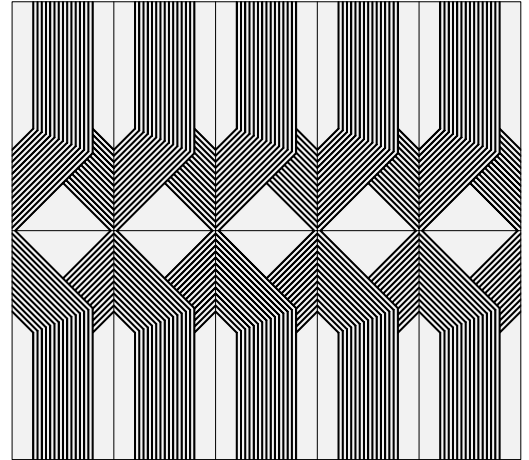

Recommended Layouts

Spirograph

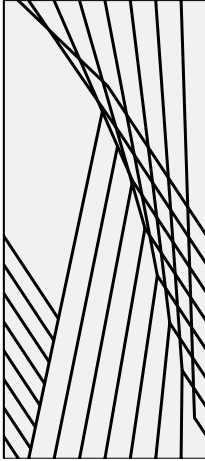

Layout 1

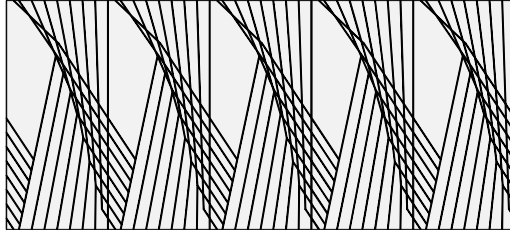

Layout 2

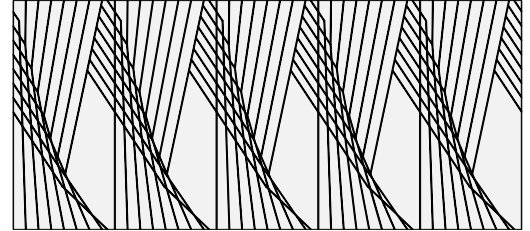

Layout 3

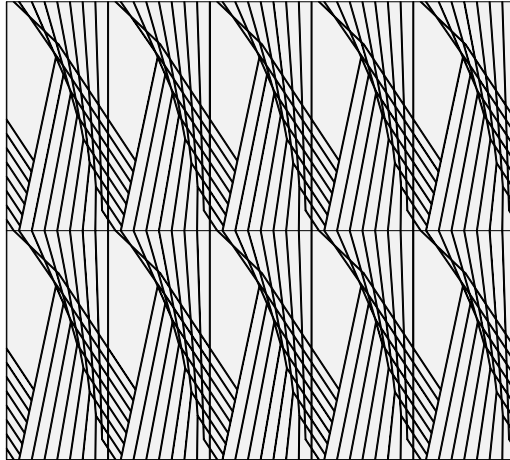

Layout 4

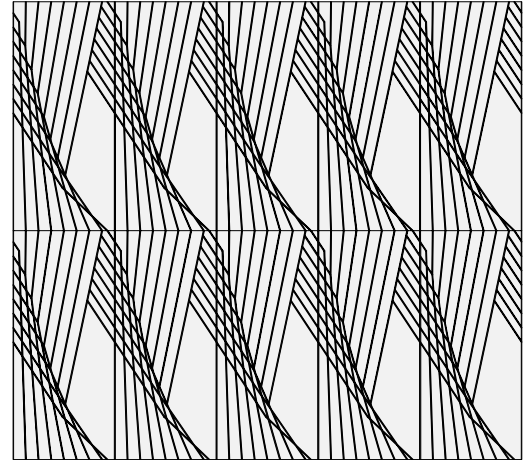

Recommended Layouts

Summit

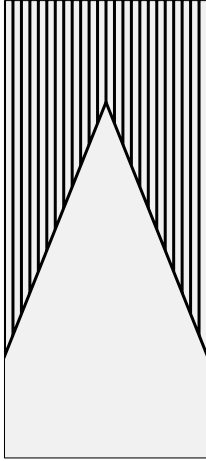

Layout 1

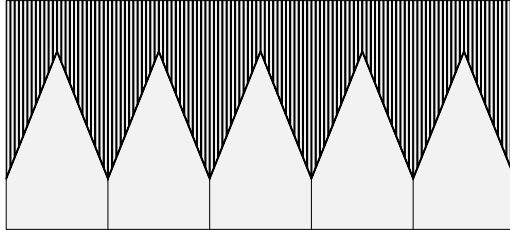

Layout 2

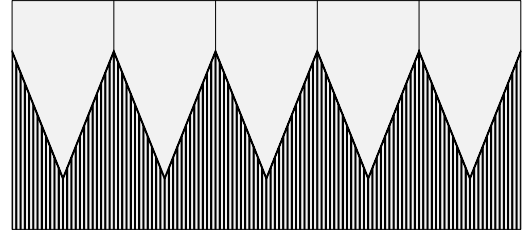

Layout 3

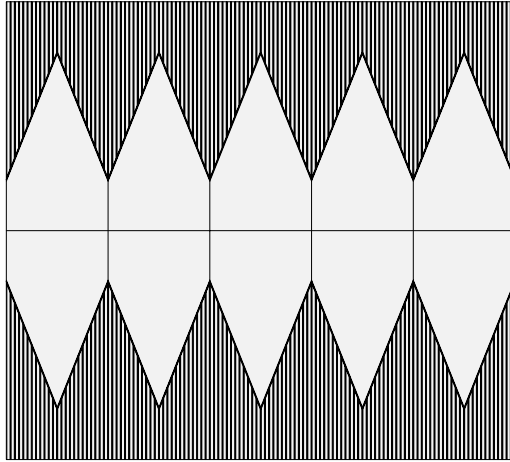

Layout 4

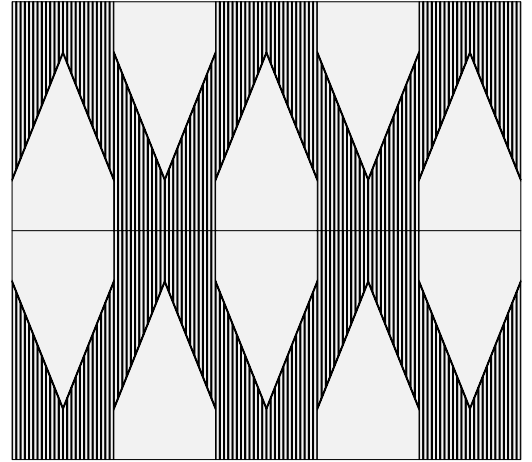

Recommended Layouts

Track

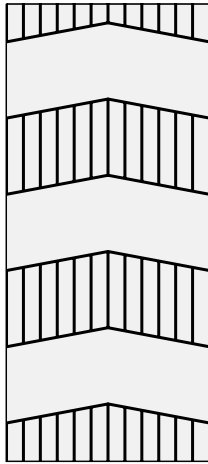

Layout 1

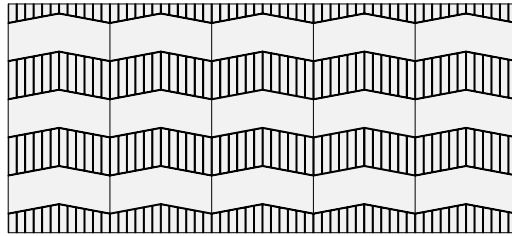

Layout 2

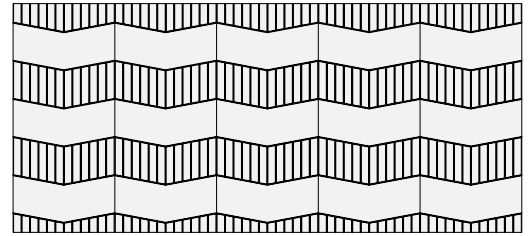

Layout 3

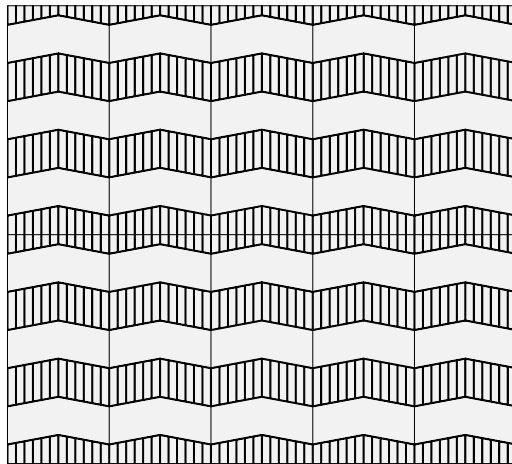

Layout 4

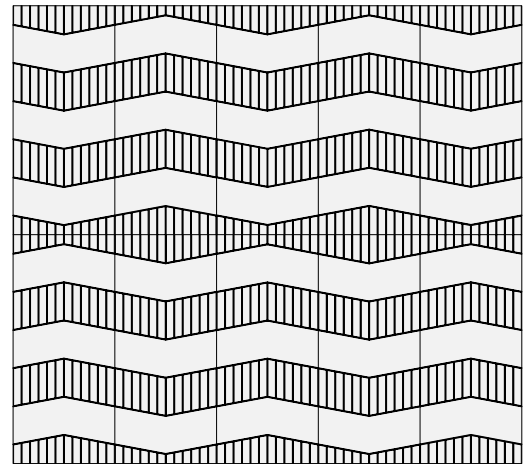

Recommended Layouts

Trellis

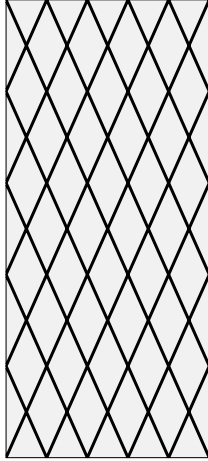

Layout 1

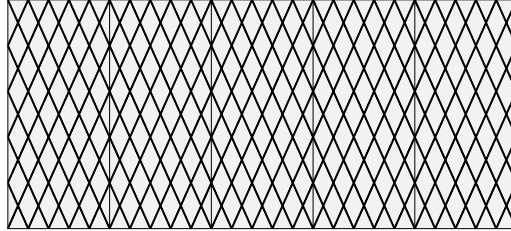

Layout 2

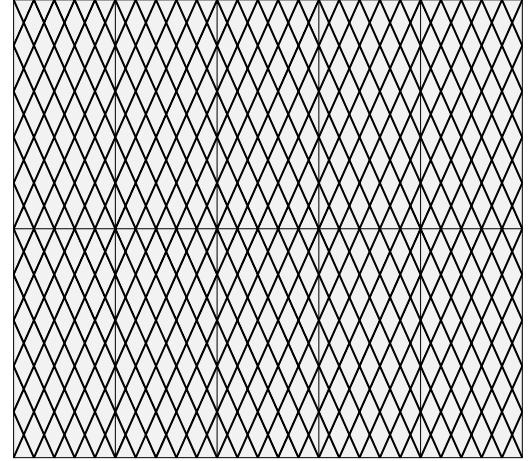

Recommended Layouts

Wavelength

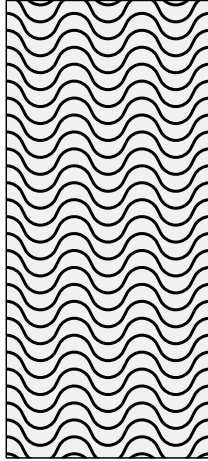

Layout 1

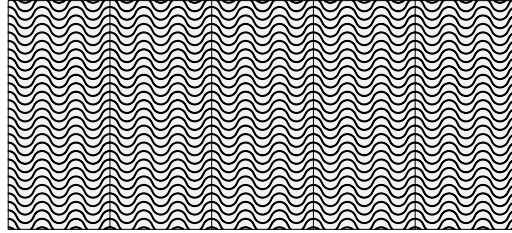

Layout 2

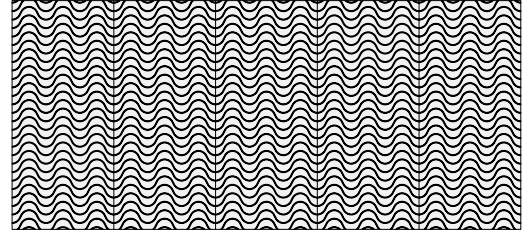

Layout 3

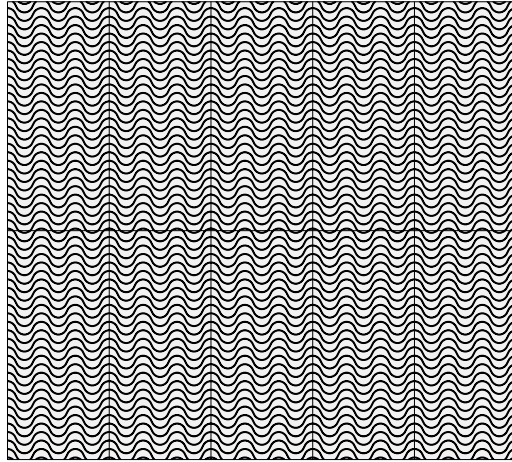

Layout 4

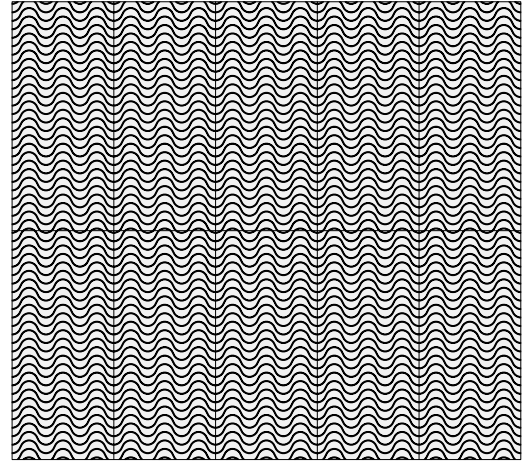

Mounting Methods

Adhesive backing

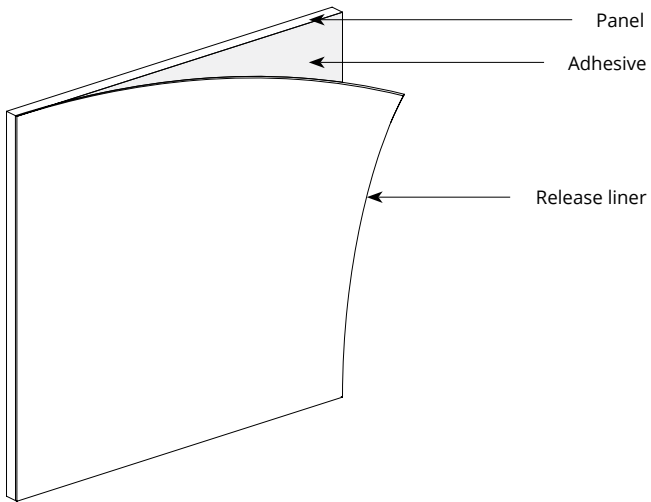

Construction adhesive

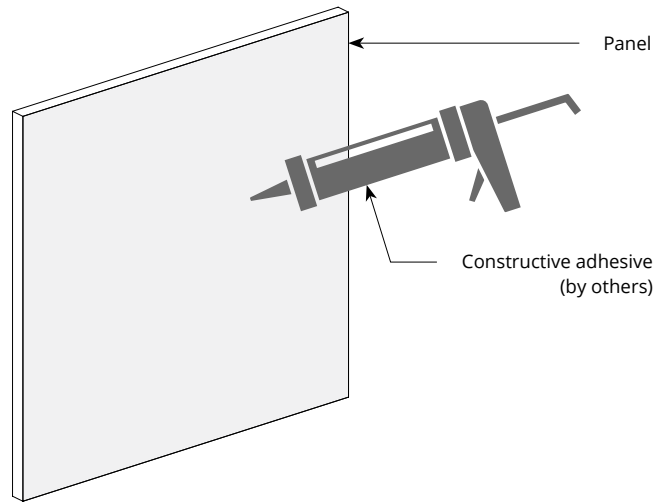

Z-clip wall mount

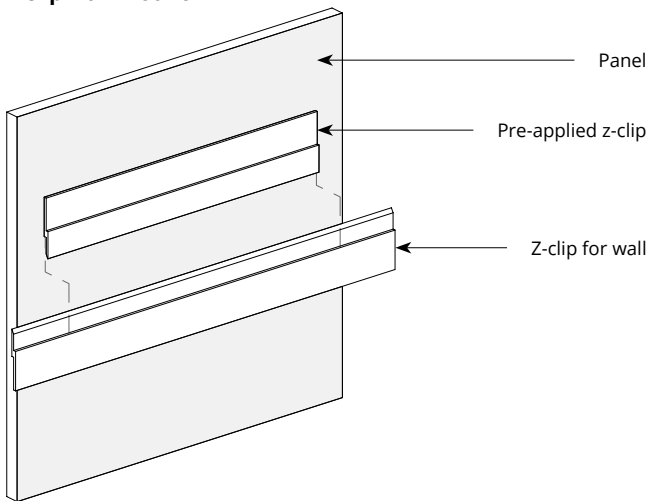

* For wall mount applications only.



Acoustic Performance

Test Method	ASTM C432-09a
Install Method	A
Rating Method	ISO 11654-1997
Test Results	<p>12mm NRC 0.45, no air gap NRC 0.54, 12mm air gap NRC 0.64, 20mm air gap SAA 0.43, no air gap SAA 0.54, 12mm air gap</p> <p>24mm NRC 0.60, no air gap SAA 0.55, no air gap</p>

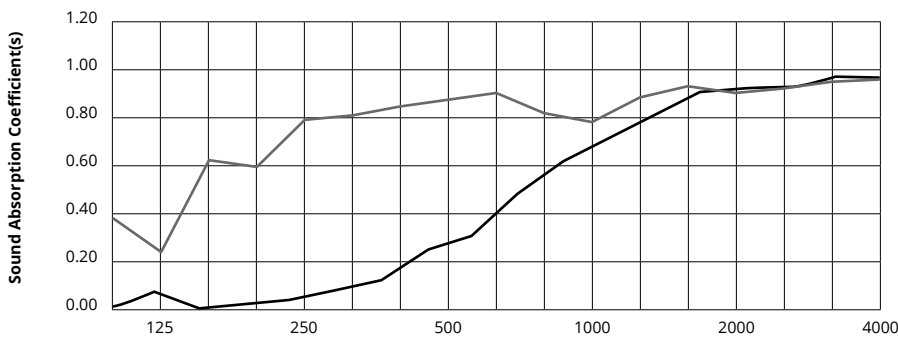

	Frequency f (Hz)	125	250	500	1000	2000	4000	NRC
	12mm	0.06	0.02	0.23	0.61	0.89	0.95	0.45
	24mm	0.02	0.57	0.41	0.58	0.87	0.85	0.60

What is a Noise Reduction Coefficient (NRC)?

You'll find the NRC rating in the specifications of all of our products. This acronym stands for Noise Reduction Coefficient, and is expressed as a single number, a rating that describes the degree to which acoustic products can absorb sound.

You can use NRC values to understand the overall performance of our acoustic wall and ceiling products. The higher the NRC, the better the product is at soaking up the sound.

Performance Indices: Noise Reduction Coefficient (NRC) results represent the absorption coefficients measured at the one third octave bands at 125, 250, 500, 1000, 2000 and 4000 Hz rounded to the nearest 0.05. Acoustic testing has been performed according to the methods mentioned above. Customization of installation of the product could alter the results. Sound Absorption Average (SAA) indicates the absorption coefficient average for the twelve one-third octave bands ranging between 200 and 2500 Hz.